

Service Service Service

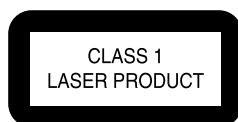

CL 16532007_000.eps
30-01-01

Service Manual



Contents

	Page
1 Technical specifications and connection facilities	2
2 Warnings, laser safety instructions and notes	3
3 Directions for use	6
4 Mechanical instructions and exploded views	16
5 Diagnostic software descriptions and troubleshooting	21
6 <i>Block- and wiring diagram</i>	
Blockdiagram	39
Wiring diagram	40
7 <i>Electrical diagrams and print-layouts</i>	<i>Diagram PWB</i>
Power supply	41 42-43
A/V Board Video control (Diagram A1)	44 46-47
A/V Board Audio (Diagram A2)	45 46-47
Display panel (Diagram D)	48 49
Bare board Standby	50 50
8 Electrical alignments	51
9 Circuit descriptions and List of abbreviations	51 54
10 Spare part list	55

© Copyright 2001 Philips Consumer Electronics B.V. Eindhoven, The Netherlands.
All rights reserved. No part of this publication may be reproduced, stored in a retrieval system or transmitted, in any form or by any means, electronic, mechanical, photocopying, or otherwise without the prior permission of Philips.



PHILIPS

1. Technical specifications

Specification

PLAYBACK SYSTEM

DVD-Video
Video CD & SVCD
CD (CD-R and CD-RW)
DVD+RW
MP3 (DVD622 only)

OPTICAL READOUT SYSTEM

Lasertype	Semiconductor AlGaAs	
Numerical Aperture	0.60 (DVD) 0.45 (VCD/CD)	
Wavelength	650 nm (DVD) 780 nm (VCD/CD)	

DVD DISC FORMAT

Medium	Optical Disc	
Diameter	12cm (8cm)	
Playing time (12cm)	One layer	2.15 h*
	Dual layer	4 h*
	Two side	4.30 h*
	Single layer	
	Two side	8 h*
Dual layer		

VIDEO FORMAT

DA Converter	10 bits
Signal handling	Components
Digital Compression	MPEG2 for DVD, MPEG1 for VCD

TV STANDARD

	(PAL/50Hz)	(NTSC/60Hz)
Number of lines	625	525
Playback	Multistandard	(PAL/NTSC)

DVD

Horiz. Resolution	720 pixels	720 pixels
Vertical Resolution	576 lines	480 lines

VCD

Horiz. Resolution	352 pixels	352 pixels
Vertical Resolution	288 lines	240 lines

VIDEO PERFORMANCE

Video output	1 Vpp into 75 ohm
RGB (SCART) output	0.7Vpp into 75 ohm
Black Level Shift	On/Off
Video Shift	Left/Right

AUDIO FORMAT

Digital	MPEG	Compressed Digital
	DTS/Dolby Digital	16, 20, 24 bits
	PCM	fs, 44.1, 48, 96 kHz

Analog Sound Stereo
Dolby Pro Logic downmix from Dolby Digital multi-channel sound
3D Sound (TruSurround) for virtual 5.1 channel sound on 2 speakers

AUDIO PERFORMANCE

DA Converter	24 bits	
DVD	fs 96 kHz	4 Hz - 44 kHz
	fs 48 kHz	4 Hz - 22 kHz
	fs 44.1 kHz	4 Hz - 20 kHz
Video CD	fs 44.1 kHz	4 Hz - 20 kHz
CD	fs 44.1 kHz	4 Hz - 20 kHz
Signal-Noise (1kHz)	100 dB	
Dynamic Range (1kHz)	97 dB	
Crosstalk (1kHz)	110 dB	
Distortion and Noise (1kHz)	88 dB	
MPEG MP3	MPEG Audio L3	

CONNECTIONS

SCART	Euroconnector
Video Output	Cinch (yellow)
Audio L+R output	Cinch (white/red)
Digital Output	1 coaxial IEC958 for CDDA / LPCM IEC1937 for MPEG1/2, Dolby Digital and DTS

CABINET

Dimensions (w x h x d)	435 x 81 x 295 mm
Weight	Approx. 3.5 Kg

GENERAL FUNCTIONALITY

Stop / Play / Pause
Fast Forward / Backward
Time Search
Step Forward / Backward
Slow Motion
Title / Chapter / Track Select
Skip Next / Previous
Repeat (Chapter / Title / All) or (Track / All)
A-B Repeat
Shuffle
Scan
New enhanced user graphical interface
Perfect Still with digital multi-tap filter
Zoom (x1.33, x2, x4) with picture enhancement
Smart Picture for convenient personal colour setting (DVD622 only)
PAL/NTSC Conversion (DVD622 only)
Screen Saver (Dim 75% after 15 min.)
3D Sound (TruSurround)
Virtual Jog Shuttle
Audio and video bit rate indicator

DVD FUNCTIONALITY

Multi-angle Selection
Audio Selection (1 out of max. 8 languages)
Subtitles Selection (1 out of max. 32 languages)
Aspect Ratio conversion (16:9, 4:3 Letterbox, 4:3 Pan Scan)
Parental Control and Disk Lock
Disc Menu support (Title Menu and Root Menu)
Resume (5 discs) after stop / standby
Programming Titles/chapters with Favourite Selection

VIDEO CD FUNCTIONALITY

Playback Control for VCD 2.0 discs
Disc Lock
Resume (5 discs) after stop / standby
Programming Tracks with Favourite Selection

AUDIO CD FUNCTIONALITY

Time Display (Total / Track / Remaining Track Time)
Full audio functionality with remote control
Programming with Favourite Track Selection

MP3 FUNCTIONALITY (DVD622 only)

Time Display (Track)
Album and Track Selection
Repeat (Disc / Album / Track)

* typical playing time for movie with 2 spoken languages and 3 subtitle languages.

Specifications subject to change without prior notice

2. Warnings and Laser safety instructions

GB WARNING

All ICs and many other semi-conductors are susceptible to electrostatic discharges (ESD). Careless handling during repair can reduce life drastically.
When repairing, make sure that you are connected with the same potential as the mass of the set via a wrist wrap with resistance.
Keep components and tools also at this potential.



NL WAARSCHUWING

Alle IC's en vele andere halfgeleiders zijn gevoelig voor elektrostatische ontladingen (ESD).
Onzorgvuldig behandelen tijdens reparatie kan de levensduur drastisch doen verminderen.
Zorg ervoor dat u tijdens reparatie via een polsband met weerstand verbonden bent met hetzelfde potentiaal als de massa van het apparaat.
Houd componenten en hulpmiddelen ook op hetzelfde potentiaal.

F ATTENTION

Tous les IC et beaucoup d'autres semi-conducteurs sont sensibles aux décharges statiques (ESD).
Leur longévité pourrait être considérablement écourtée par le fait qu'aucune précaution n'est prise à leur manipulation.
Lors de réparations, s'assurer de bien être relié au même potentiel que la masse de l'appareil et enfiler le bracelet serti d'une résistance de sécurité.
Veiller à ce que les composants ainsi que les outils que l'on utilise soient également à ce potentiel.

D WARNUNG

Alle IC und viele andere Halbleiter sind empfindlich gegen elektrostatische Entladungen (ESD).
Unvorsorgfältige Behandlung bei der Reparatur kann die Lebensdauer drastisch vermindern.
Sorgen sie dafür, das Sie im Reparaturfall über ein Pulsarmband mit Widerstand mit dem Massepotential des Gerätes verbunden sind.
Halten Sie Bauteile und Hilfsmittel ebenfalls auf diesem Potential.

I AVVERTIMENTO

Tutti IC e parecchi semi-conduttori sono sensibili alle scariche statiche (ESD).
La loro longevità potrebbe essere fortemente ridatta in caso di non osservazione della più grande cauzione alla loro manipolazione.
Durante le riparazioni occorre quindi essere collegato allo stesso potenziale che quello della massa dell'apparecchio tramite un braccialetto a resistenza.
Assicurarsi che i componenti e anche gli utensili con quali si lavora siano anche a questo potenziale.

GB

Safety regulations require that the set be restored to its original condition and that parts which are identical with those specified be used.

D

Bei jeder Reparatur sind die geltenden Sicherheitsvorschriften zu beachten.
Der Originalzustand des Gerats darf nicht verändert werden.
Für Reparaturen sind Original-Ersatzteile zu verwenden.

NL

Veiligheidsbepalingen vereisen, dat het apparaat in zijn oorspronkelijke toestand wordt terug gebracht en dat onderdelen, identiek aan de gespecificeerde worden toegepast.

I

Le norme di sicurezza esigono che l'apparecchio venga rimesso nelle condizioni originali e che siano utilizzati pezzi di ricambio identici a quelli specificati.

F

Les normes de sécurité exigent que l'appareil soit remis à l'état d'origine et que soient utilisées les pièces de rechange identiques à celles spécifiées.

SHOCK, FIRE HAZARD SERVICE TEST:

CAUTION: After servicing this appliance and prior to returning to customer, measure the resistance between either primary AC cord connector pins (with unit NOT connected to AC mains and its Power switch ON), and the face or Front Panel of product and controls and chassis bottom,
Any resistance measurement less than 1 Megohms should cause unit to be repaired or corrected before AC power is applied, and verified before return to user/customer.
Ref.UL Standard NO.1492.

NOTE ON SAFETY:

Symbol : Fire or electrical shock hazard. Only original parts should be used to replace any part with symbol .
Any other component substitution (other than original type), may increase risk or fire or electrical shock hazard.

LASER SAFETY

This unit employs a laser. Only a qualified service person should remove the cover or attempt to service this device, due to possible eye injury.

LASER DEVICE UNIT

Type:	SemiconductorlaserGaAIAs
Wave length:	650 nm (DVD) 780 nm (VCD/CD)
Output Power:	7 mW (DVD) 10 mW (VCD/CD)
Beam divergence:	60 degree



USE OF CONTROLS OR ADJUSTMENTS OR PERFORMANCE OF PROCEDURE OTHER THAN THOSE SPECIFIED HEREIN MAY RESULT IN HAZARDOUS RADIATION EXPOSURE.

AVOID DIRECT EXPOSURE TO BEAM

WARNING

The use of optical instruments with this product will increase eye hazard.
Repair handling should take place as much as possible with a disc loaded inside the player

WARNING LOCATION: INSIDE ON LASER COVERSIELD

CAUTION VISIBLE AND INVISIBLE LASER RADIATION WHEN OPEN AVOID EXPOSURE TO BEAM
ADVARSEL SYNLIG OG USYNLIG LASERSTRÅLING VED ÅBNING UNDGÅ UDSÆTTELSE FOR STRÅLING
ADVARSEL SYNLIG OG USYNLIG LASERSTRÅLING NÅR DEKSEL ÅPNES UNNGÅ EKSPONERING FOR STRÅLEN
WARNING SYNLIG OCH OSYNLIG LASERSTRÅLNING NÅR DENNA DEL ÄR ÖPPNAD BETRAKTA EJ STRÅLEN
VARO! AVATT AESSA OLET ALTTIINA NÄKYVÄLLE JA NÄKYMÄTT ÖMÄLLE LASER SÄTEILYLLE. ÄLÄ KAT SO SÄTEESEEN
VORSICHT SICHTBARE UND UNSICHTBARE LASERSTRAHLUNG WENN ABDECKUNG GEÖFFNET NICHT DEM STRAHL AUSSETSEN
DANGER VISIBLE AND INVISIBLE LASER RADIATION WHEN OPEN AVOID DIRECT EXPOSURE TO BEAM
ATTENTION RAYONNEMENT LASER VISIBLE ET INVISIBLE EN CAS D'OUVERTURE EXPOSITION DANGEREUSE AU FAISCEAU

Warning for powersupply on position 1005

The primary side of the powersupply including the heatsink carries live mains voltage when the player is connected to the mains even when the player is switched off !

This primary area is not shielded so it is possible to touch copper tracks and/or components when servicing the player. Service personnel have to take precautions to prevent touching this area or components in this area .

The primary side of the powersupply has been indicated with a lightning stroke and a stripe-marked printed on the printed wiring board

2.1 Notes

2.1.1 DVD-Module

For repair of the DVD-module ASD1, the service manual 3122 785 10840 has to be used.

2.1.2 Compair

For assistance with the repair process of the monoboard an electronic Fault finding guidance has been developed , this program is called COMPAIR.

This COMPAIR program is available on CDROM.

The Version of the CDROM for repair of the monoboard is V1.3 and can be ordered with codenumber : 4822 727 21637. This is an update CDROM , so when the COMPAIR CDROM is used for the first time , one has to install the COMPAIR ENGINE CDROM V1.2 first.

The V1.2 CDROM can be ordered with codenumber 4822 727 634 and has to registered after installation , the procedure for registration is explained in the help file of the program and in the booklet from the CDROM.

The cable to connect the monoboard with a PC can be ordered with codenumber 3122 785 90017.

All the hardware and software requirements of the systems necessary for working with COMPAIR is described on the CDROM.

3. Directions for use

Important Note

DK

Advarsel:

Laserudstråling ved åbning når sikkerhedsafbrydere er ude af funktion. Undgå u tsetteselse for stråling.

Bemærk:

Netafbryderen POWER er sekundært indkoblet og afbryder ikke strømmen fra nettet. Den indbyggede neddel er derfor tilsluttet til lysnettet så længe netstikket sidder i stikkontakten.

N

Observer:

Netafbryderen POWER er sekundært indkoblet. Den indbyggede neddel er derfor ikke frakoplet nettet så længe apparatet er tilsluttet nettkontakten.

S

Klass 1 laserapparat

Varning!

Om apparaten används på annat sätt än i denna bruksanvisning specificerats, kann användaren utsättas för laserstrålning som överskrider gränsen för laserklass 1.

Observera!

Strömavbrytaren POWER är sekundärt kopplad och inte bryter strömmen från nätet. Den inbyggda neddelen är därför ansluten till elnätet så länge stekproppen sitter i vägguttaget.

SF

Luolan 1 laseriläite + Klass 1 laserapparaat

Varoitus!

Laitteen käyttäminen muulla kuin tässä käyttöohjeessa mainituilla tavalla saattaa altistaa käyttäjän turvallisuusluokan 1 ylittävälle laserlähelle.

Huom.

Toiminimivaliisin POWER on kytketty toisiopuolelle, eikä se lyryte laitetta irta sähköverikosta. Säännökennettu verkko-osa on kytkettyntä sähköverikkoon aina silloin, kun pistoke on pistorasiasa.

This product incorporates copyright protection technology that is protected by method claims of certain U.S. patents and other intellectual property rights owned by Macrovision Corporation and other rights owners. Use of this copyright protection technology must be authorized by Macrovision Corporation, and is intended for home and other limited viewing uses only unless otherwise authorized by Macrovision Corporation. Reverse engineering or disassembly is prohibited.

Manufactured under license from Dolby Laboratories. "Dolby" and the double-D symbol are trademarks of Dolby Laboratories. Confidential Unpublished Works. © 1992 - 1997 Dolby Laboratories, Inc. All rights reserved.

Important Note for Users in the UK

Mains plug

This apparatus is fitted with an approved 13 Amp plug. To change a fuse in this type of plug proceed as follows:

1. Remove fuse cover and fuse.
2. Fix new fuse which should be a BS1362, 5 Amp, A.S.T.A. or BSI approved type.
3. Refit the fuse cover.

If the fitted plug is not suitable for your socket outlets, it should be cut off and an appropriate plug fitted in its place. If the mains plug contains a fuse, this should have a value of 5 Amp. If a plug without a fuse is used, the fuse at the distribution board should not be greater than 5 Amp.

Note: The severed plug must be disposed of to avoid a possible shock hazard should it be inserted into a 13 Amp socket elsewhere.

How to connect a plug

The wires in the mains lead are coloured with the following code: blue = neutral (N), brown = live (L).

As these colours may not correspond with the colour markings identifying the terminals in your plug, proceed as follows:

- Connect the blue wire to the terminal marked N or coloured black.
- Connect the brown wire to the terminal marked L or coloured red.
- Do not connect either wire to the earth terminal in the plug, marked E (or e) or coloured green (or green and yellow).

Before replacing the plug cover, make certain that the cord grip is clamped over the sheath of the lead - not simply over the two wires.

Copyright in the U.K.
Recording and playback of material may require consent. See Copyright Act 1956 and The Performer's Protection Acts 1958 to 1972.

2 IMPORTANT NOTE



DVD-622
DVD-612



PHILIPS



Let's make things better.

General Information



The region code for this set is 2.

Since it is usual for DVD movies to be released at different times in different regions of the world, all players have region codes and discs can have an optional region code. If you load a disc of a different region code to your player, you will see the region code notice on the screen. The disc will not playback and should be unloaded.

NOTE:
PICTURES SHOWN MAYBE DIFFERENT BETWEEN COUNTRIES.

NEVER MAKE OR CHANGE CONNECTIONS WITH THE POWER SWITCHED ON.

CAUTION (WARNING LOCATION: ON THE BACKPLATE OF SET)

Manufactured under license from Digital Theater Systems, Inc. US Pat. No. 5,451,942 and other world-wide patents issued and pending. "DTS" and "DTS DIGITAL SURROUND" are trademarks of Digital Theater Systems, Inc. © 1996 Digital Theater Systems, Inc. All rights reserved.

CE The DVD-VIDEO player is in conformity with the EMC directive and low-voltage directive.

TruSurround and the SRS symbol are trademarks of SRS Labs, Inc. TruSurround technology is manufactured under license from SRS Labs, Inc.

TruSurround™
by **SRS**

For Customer Use:

Read carefully the information located at the bottom of your DVD-VIDEO player and enter below the Serial No. Retain this information for future reference.

Model No. DVD-VIDEO _____
Serial No. _____

Contents

English

Introduction	
Philips DVD-Video Introduction	6
Unpacking	6
Remote Control Battery Installation	6
Safety Information	6
Cleaning Discs	6
Functional Overview	
Front and Rear Panels	7
Remote Control	8
Preparation	
General Notes	9
Connecting to a TV	9
Connecting to Optional Equipment	9-10
NTSC/PAL Settings	10
NTSC/PAL Conversion	10
General Explanation	10
Initial Setup	11
Menu Bar/Status Window	11
Temporary Feedback Field Icons	12
Personal Preferences	12-13
Operation	
Loading Discs	14
Playing a DVD-Video and Video CD Disc	14
General Features	14-16
Special DVD Features	16
Special VCD & SVCD Features	17
Playing an Audio CD	17
FTS Programme	17
MP3 Disc Features	18
Access Control	
Access Control: Child Lock	19
Access Control: Parental Control	19-20
Before Requesting Service	
Before Requesting Service	21
Specifications	
Specifications	22

Laser safety

This unit employs a laser. Due to possible eye injury, only a qualified service person should remove the cover or attempt to service this device.

USE OF CONTROLS OR ADJUSTMENTS OR PERFORMANCE OF PROCEDURES OTHER THAN THOSE SPECIFIED HEREIN MAY RESULT IN HAZARDOUS RADIATION EXPOSURE.

LASER

Type	Semiconductor laser GaAlAs
Wave length	650 nm (DVD)
	780 nm (VCD/CD)
Output Power	7 mW (DVD)
	10 mW (VCD/CD)
Beam divergence	60 degree

CAUTION VISIBLE AND INVISIBLE LASER RADIATION WHEN OPEN AVOID EXPOSURE TO BEAM ADVARSEL SYNLIG OG USYNLIG LASERSTRÅLING VED ÅBNING UNDGÅ UDSÆTTELSE FOR STRÅLING ADVARSEL SYNLIG OG USYNLIG LASERSTRÅLING NÅR DEKSEL ÅPNES UNNGÅ EKSPONERING FOR STRÅLEN VARNING SYNLIG OCH OSYNLIG LASERSTRÅLING NÅR DENNAS DEL ÄR ÖPPNAD BETRÄKTA EJ STRÅLEN VARO! AVATTIASSA OLET ALTTIINA NÄKRYÄLLE JÄ NÄKRYÄTTÖMÄLLE LASER SÄTELYLLE: ÄLÄ KATSO SÄTSEEN VORSICHT SICHTBARE UND UNSICHTBARE LASERSTRÄHLUNG WENN ABDECKUNG GEÖFFNET NICHT DEM STRALH AUSSETZEN DANGER VISIBLE AND INVISIBLE LASER RADIATION WHEN OPEN AVOID DIRECT EXPOSURE TO BEAM ATTENTION RAYONNEMENT LASER VISIBLE ET INVISIBLE EN CAS D'OUVERTURE EXPOSITION DANGEREUSE AU FAISCEAU
--

Functional Overview

Front and Rear Panels

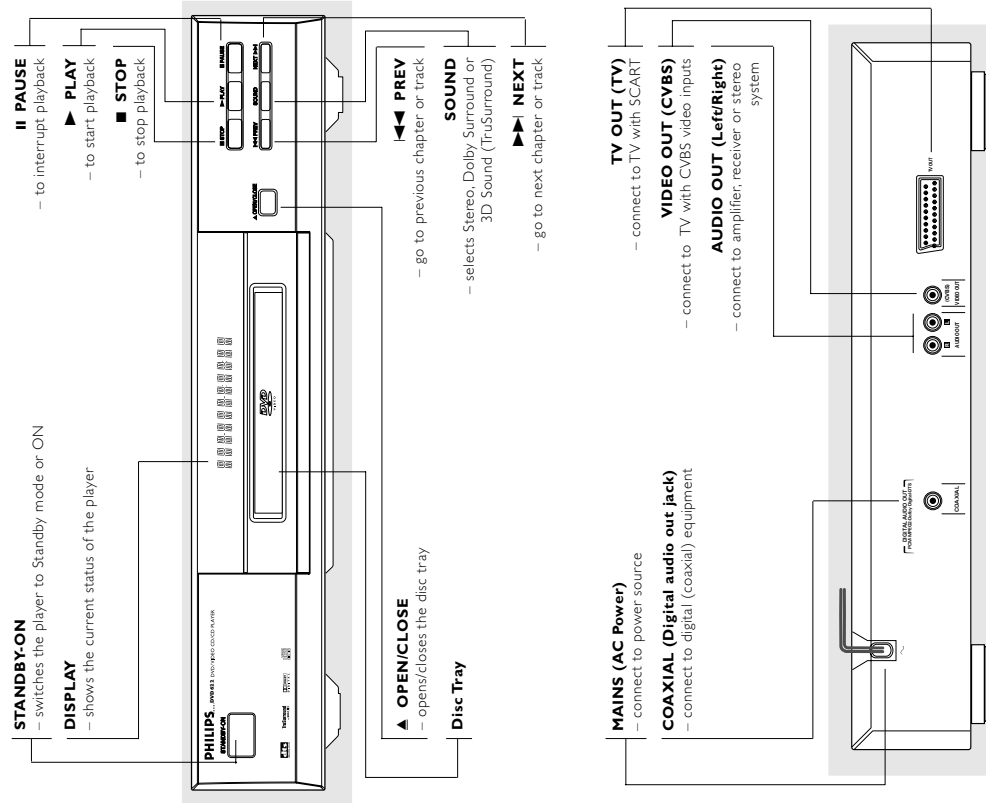

If any item is damaged or missing, contact your retailer or Philips.
Keep the packaging materials for future transportation.

Remote Control Battery Installation

- Insert batteries as indicated inside the battery compartment.

Caution: Do not mix old and new batteries. Never mix different types of batteries (standard, alkaline, etc.)

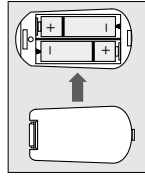

Safety Information

- Do not expose the system to excessive moisture, rain, sand or heat sources.
- Place the player on a firm, flat surface.
- Keep the player away from domestic heating equipment and direct sunlight.
- In a cabinet, allow about 2.5 cm (1 inch) of free space all around the player for adequate ventilation.
- If the DVD-Video player cannot read CDs/DVDs correctly, use a commonly available cleaning CD/DVD to clean the lens before taking the DVD-Video player to be repaired.
- Other cleaning methods may destroy the lens. Always keep the tray closed to avoid dust on the lens.
- The lens may cloud over when the DVD-Video player is suddenly moved from cold to warm surroundings. Playing a CD/DVD is not possible then. Leave the power on for about one hour with no disc in the unit until normal playback is possible.

Cleaning Discs

- When a disc becomes dirty, clean it with a cleaning cloth.
- Wipe the disc from the centre out, in a straight line.
- Do not use solvents such as benzene, thinner, commercially available cleaners, or anti-static spray intended for analog discs.



Introduction

Philips DVD-Video Introduction

Your Philips DVD-Video player will playback digital video discs conforming to the universal DVD-Video Standard. With it, you will be able to enjoy full-length movies with true cinema picture quality, as well as stereo or multi-channel sound (depending on the disc and your playback setup). The unique features of DVD-Video, such as selection of sound track, subtitle, languages and different camera angles (disc dependent), are all supported.

In addition to DVD-Video discs, you will be able to playback all Video CDs, SVCDs and Audio CDs (including finalised CD Recordable and CD Rewritable).

DVD-Video
You will recognise DVD-Video discs by the logo shown.

Depending on the material on the disc (a movie, video clips, a drama series, etc.), the disc may have one or more Titles.

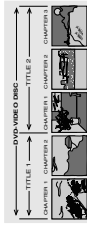

Video CD

You will recognise Video CDs by the logo shown.



Super-VCD (SVCD)

SVCD discs based on the Super-VCD IO Standard referring to Standard of Electronics Industry of the People's Republic of China.

Audio CD

Audio CDs contain music tracks only. You will recognise Audio CDs by their logo shown.



MP3 (MPEG Audio Layer-3) (DVD622 only)

This player supports MP3 which contains compressed music tracks.

Note:

- Only the first session of multisection discs is supported

Unpacking

First check and identify the contents of your DVD-Video player package.

- You should have the following items.
 - DVD-Video player
 - Remote Control with batteries
 - Audio cable
 - SCART cable
 - Instructions for use

Remote Control

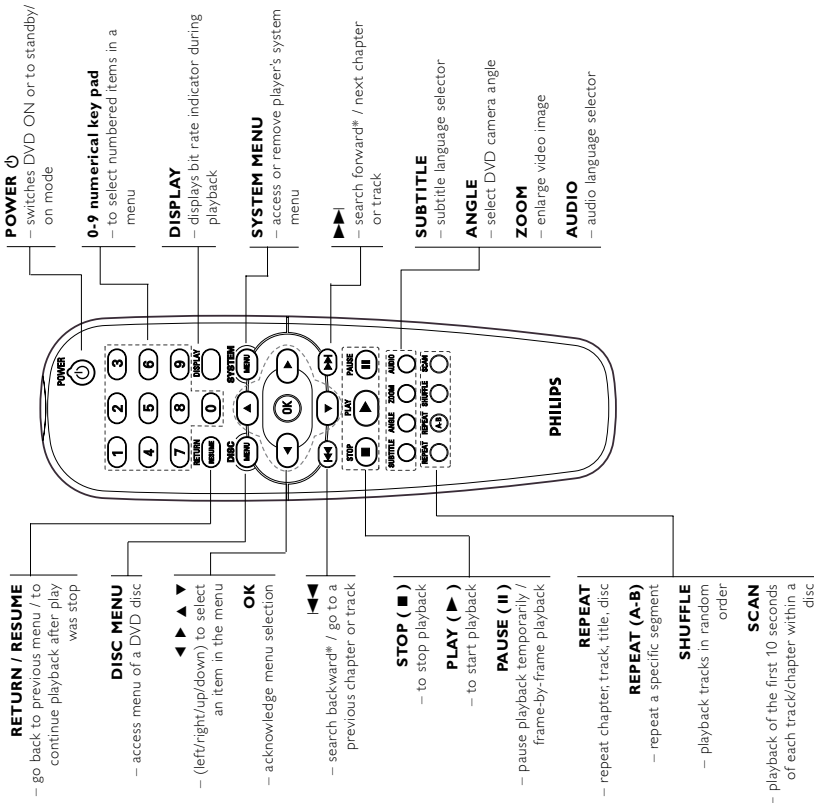

* Press key for about 2 seconds

Preparation

General Notes

- Depending on your TV and other equipment, you wish to connect, there are various ways you could connect the player. Use only one of the connections described below.
- Please refer to the manuals of your TV, VCR, Stereo System or other devices as necessary to make the best connections.
- For better sound reproduction, connect the player's audio out jacks to the audio in jacks of your amplifier receiver, stereo or AV equipment. See 'Connecting to optional equipment'.

Caution:

- Do not connect the player's audio out jack to the phono in jack of your audio system.
- Do not connect your DVD-player via your VCR. The DVD image could be distorted by the copy protection system.

Connecting to a TV

- Connect the SCART to the corresponding connector on the TV using the SCART cable supplied (Z).
- If your TV is not equipped with a SCART you can select one of the following alternative connections:

Video CVBS connection

- Connect the Video out (CVBS) jack to the video in jack on the TV using an optional video cable (X).
- Connect the Left and Right audio out jacks of the DVD player to the audio left/right in jacks on the TV (A).

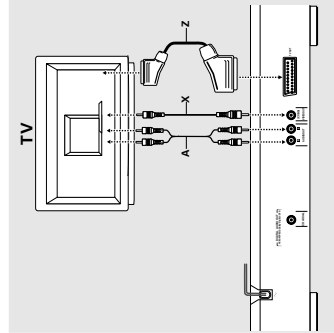

Connecting to Optional Equipment

Connecting to an amplifier equipped with two channel analog stereo or Dolby Surround

- Connect the audio Left and Right out jacks of the DVD player to the audio left and right in jack on your amplifier, receiver or stereo system, using an audio cable (A).

Connecting to an amplifier equipped with two channel digital stereo (PCM) or to an AV receiver equipped with a multi-channel decoder (Dolby Digital™, MPEG 2 and DTS)

- Connect the player's digital audio out jack (coaxial F) to the corresponding in jack on your amplifier. Use an optional digital (coaxial F) audio cable.
- You will need to activate the player's digital output (see 'Personal Preferences').

Digital Multi-channel sound

Digital multi-channel connection provides the best sound quality. For this you need a multi-channel AV receiver that supports one or more of the audio formats supported by your DVD player (MPEG 2, Dolby Digital™ and DTS). Check the receiver manual and the logos on the front of the receiver.

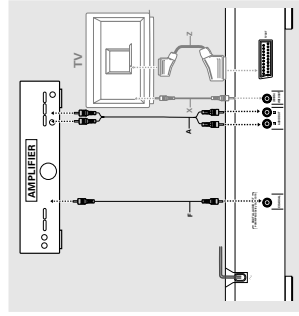

- Note:**
- If the audio format of the digital output does not match the capabilities of your receiver, the receiver will produce a strong, distorted sound or no sound at all.
 - Six Channel Digital Surround Sound via digital connection can only be obtained if your receiver is equipped with a Digital Multi-channel decoder.
 - To see the selected audio format of the current DVD in the Status Window, press SYSTEM MENU or Audio.

NTSC/PAL Settings

You can switch the NTSC/PAL setting of the DVD player to match the video signal of your TV. This setting only affects the television's on-screen display that shows the stop and setup modes. You may select either NTSC or PAL. To change the DVD player setting to PAL or NTSC, follow the steps below.

- 1 Unplug the DVD player from the mains.
- 2 Press and hold **■** and **▶▶** on the front of the DVD player. While holding **■** and **▶▶**, plug in the mains.
- 3 After PAL or NTSC appears on the display panel of the DVD player, release **■** and **▶▶**, at the same time. The PAL or NTSC that appears on the display panel indicates the current setting.
- 4 To change the setting, press **▶▶▶** within three seconds. The new setting (PAL or NTSC) will appear on the display panel.

NTSC/PAL Conversion (DVD622 on/)

This player is equipped with NTSC/PAL conversion feature to convert the video output of the disc to match with your TV system. The conversion supported are as per below.

Disc Type	Format	Output format	
		Format	Selected mode
DVD	NTSC	NTSC	PAL
	PAL	NTSC	PAL
	PAL	NTSC	PAL
VCD	NTSC	NTSC	PAL
	PAL	NTSC	PAL
	PAL	NTSC	PAL

- 1 In the Preference Menu, select **TV System**.
- 2 Press **▲** or **▼** to select PAL/NTSC or AUTO.

- Notes:**
- AUTO mode can only be selected when using a multi-system TV.
 - This is applicable for CVBS output on cinch and SCART only

General Explanation

About this manual

This manual gives the basic instructions for operating the DVD player. Some DVDs require specific operation or allow only limited operation during playback, which may not respond to all operating commands. When this occurs, the symbol **✕** appears on the TV screen, indicating that the operation is not permitted by the player or the disc.

Remote control operation

- Unless stated, all operations can be carried out with the remote control. Always point the remote control directly at the player, making sure there are no obstructions in the path of the infrared beam.
- Corresponding keys on the front panel of the player can also be used.

Menu bar operation

- A number of operations can be carried out via the menu bar on the screen. The menu bar can be accessed by pressing the cursor keys on the remote control.
- Pressing SYSTEM MENU while the menu bar is displayed will clear the menu bar from the screen.
- The selected item will be highlighted and the appropriate cursor keys to operate will be displayed below the icon.
- < or > indicates that more items are available at the left/right of the menu bar. Press ◀ or ▶ to select these items.

Initial Setup (Virgin Mode)

General

In Initial Setup you may have to set your preferences for some of the player's features; (not applicable for all models)

Operation

After switching on the player for the very first time, the Initial Setup Screen will appear. The menu for the first item to be set is displayed and the first option is highlighted.

- Use the **▼** **▲** keys to go through the options in the menu. The icon of the selected option will be highlighted.
- Use OK to confirm your selection and to go to the next menu.

Note:

- Preferences have to be set in the order of which the item menus will appear on the screen.
- The Initial Setup screen will only disappear after the settings for the last item have been confirmed.
- If any keys other than **▼** **▲** or OK are pressed, **✕** will appear on the screen.
- If the player is switched off while setting personal preferences, all preferences have to be set again after switching the player on again.

The following items may have to be set in Initial Setup:

Menu language

You can choose from different languages. The On Screen Menu will be displayed in the language available on the player.

Audio language

You can choose from different languages. If available on the disc, the player will play the audio in the selected language. If the selected language is not available, speech will revert to the first spoken language on the disc.

Subtitle language

You can choose from different subtitle languages. If available on the disc, subtitles will be in the language chosen. If the selected language is not available, subtitles will revert to the first subtitle language on the disc.

TV Shape

If you have a wide screen (16:9) TV, select 16:9. If you have a regular (4:3) TV, select 4:3. Letterbox for a wide-screen picture with black bars top and bottom, or Pan Scan, for a full-height picture with the sides trimmed. If a disc supports the format, the picture will be shown accordingly.

Country

Select your country. This is used as input for the Parental Control feature (see Access Control).

Note:

- All these items may have to be set during Initial Setup. After that, they can always be changed in the Personal Preferences Menu.

Menu Bar/Status Window

As there are multiple menu-bars, the items on the menu-bar are arranged according to usage, availability of direct access keys. Pressing the OSD keys once will toggle through menu-bar-1, menu-bar-2, menu-bar-3 and OFF.

Menu-bar-1

- Personal Preferences
- Subtitle Language
- Audio Language
- Colour
- Sound

Menu-bar-2

- Step
- Slow motion
- Fast motion
- Angle
- Zoom

Menu-bar-3

- Title
- Chapter
- Time Search
- Favourite Track Selection (FTS)

Temporary Feedback Field Icons

- scan
- repeat
- title
- track
- chapter
- shuffle
- shuffle
- repeat
- repeat
- angle
- locked
- safe
- resume
- action

Picture

- **TV Shape**

See 'Initial Setup'

- **Black level shift (NTSC only)**

Select ON for adapting the colour dynamics to obtain richer contrasts.



- **Video shift**

The factory centres the video on your screen. Use this setting to personalize the position of the picture on your TV by scrolling it to the left or right.

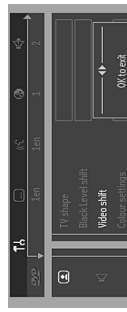

- **Colour settings (DVD622 only)**

You can select one of five predefined sets of colour settings and one set (Personal) which you can define yourself.



- **Personal colour (DVD622 only)**

Allows you to fine-tune the selected colour settings saturation, brightness and contrast.

Sound

- **Digital output**

Factory setting: ALL. This means coaxial output is on. If you are not connecting equipment with a digital input, change the setting to OFF.

If your equipment doesn't include a digital multi-channel decoder, set the digital output to PCM (Pulse Code Modulation).



- **Analog output**

Select Stereo, Dolby Surround or 3D sound (TruSurround) to match your system's playback capability.



- **Night Mode**

Optimizes the dynamics of the sound for low volume playback.

- **Karaoke vocal**

Put this setting to ON only when a multi-channel karaoke DVD is being played. The karaoke channels on the disc will then be mixed into a normal stereo sound.

Language

Select the required Menu, Audio and Subtitle language. See 'Initial Setup'. Audio language and Subtitle language can also be adapted via the Menu bar on the screen.

Features

- **Access Control**

Access Control contains the following features:
 Child Lock - When Child Lock is set to ON, a 4-digit code needs to be entered in order to playback discs.
 Parental control - Allows the conditional presentation of DVDs containing Parental Control information (See 'Access Control').

- **Status Window**

Displays the current status of the player and is displayed with the menu bar. When disc playback is stopped, it is displayed with the 'Temporary Feedback Field' in the default screen. See 'On-Screen Display' information:
 Factory setting is ON. Select OFF to suppress display of the Status Window.



- **Bit Rate Indicator**

When activated, the bit rate for video, audio as well as total bit rate is displayed. This is only applicable during playback of DVD and SVCD discs.



- **Help text**

When set to ON, help text describes the icons selected. Select OFF if you no longer require the help text.

Personal Preferences

You can set your own personal preferences on the player.

General operation:

- Press SYSTEM MENU on the remote control.
- Select [] in the menu bar.
- Use the Personal Preferences menu appears.
- Use the left and right arrow keys to toggle through the menus, submenus and submenu options.
- When a menu item is selected, the cursor keys (on the remote control) to operate the item are displayed next to the item.
- Press OK to confirm and return to the main menu.
- The following items can be adapted:

Operation

English

Loading Discs

- 1 Press OPEN/CLOSE on the front of the player to open disc tray.
- 2 Load your chosen disc in the tray, label side up.
- 3 Press OPEN/CLOSE again, to close the tray.
→ REC/II appears in the status window and on the player display, and playback starts automatically.

Note:

- If Child Lock is set to ON and the disc inserted is not authorised, the 4-digit code must be entered and/or the disc must be authorised (see 'Access Control').

Playing a DVD-video and Video CD disc



- After inserting the disc, playback starts automatically and the status window of the player display shows the type of disc loaded, as well as disc's information and playing time.
The disc may invite you to select an item from a menu. If the selections are numbered, press the appropriate numerical key; if not, use the ▲, ▼, ◀, ▶ keys to highlight your selection, then press OK.
- The currently playing title and chapter number are displayed.
- Playback may stop at the end of the Title, and then may return to the DVD menu. To go on to the next title, press ▲.
- To stop playback, press ■.
- → The default screen will appear, giving information about the current status.
- You can resume playback from the point at which you stopped playback. Press ▶ when you see the Resume icon on the screen, press ▲ again.
- → The RESUME feature applies not only to the disc, in the player, but also to the last four discs you have played. Simply reload the disc and press RESUME on the remote control or, press ▶ when you see the Resume icon ▶ on the screen, then press ▶ again.

Note:

- DVDs may have a region code. Your player will not play discs that have a region code different from the region code of your player.

General features

Note:

- Unless stated, all operations described are based on remote control operation. A number of operations can also be carried out via the menu bar on the screen.

Moving to another title/chapter

When a disc has more than one title or chapter, you can move to another title/ chapter as follows:
Press SYSTEM MENU, then select ■ or ■ in the menu bar.

- Press ▲ or ▼ to select a title/chapter.
- Note:
– If the number has more than one digit, press the keys in rapid succession.

Slow Motion

- Select ■ (SLOW MOTION) in the menu bar.
- Use the ▼ keys to enter the SLOW MOTION menu.
- → The player will now go into PAUSE mode.
- Use the cursor keys ◀▶ to select the required speed: -1, -1/2, -1/4 or -1/8 (backward), or +1/8, +1/4, +1/2, or +1 (forward).
- Select 1 to play the disc at normal speed again.
- If II is pressed, the speed will be set to zero (PAUSE).
- To exit slow motion mode, press ▲ and ▲.

Still Picture and Frame-by-frame playback

- Select ■ (STEP) in the menu bar.
- Use the ▼ key to enter the picture by picture menu.
- → The player will now go into PAUSE mode.
- Use the cursor keys ◀▶ to select the previous or next picture frame.
- To exit STEP mode, press ▶ or ▲.
- You can also step forward by pressing II repeatedly on the remote control.

Scan

- Scanning plays the first 10 seconds of each chapter/index on the disc.
- Press SCAN.
- To continue playback at your chosen track, press SCAN again or press ▶.

Search

- Select ■ (FAST MOTION) in the menu bar.
- Use the ▼ keys to enter the FAST MOTION menu.
- Use the ◀▶ keys to select the required speed: -32, -8 or -4 (backward), or +4, +8, +32 (forward).
- Select 1 to play the disc at normal speed again.
- To exit FAST MOTION mode, press ▶ or ▲.
- To search forward or backward through different speeds, you can also hold down ◀▶ or ▶▶.

Repeat



DVD-Video Discs - Repeat chapter/ title/disc

- To repeat the currently playing chapter, press REPEAT.
- → REPEAT CHPT appears on the player display.
- To repeat the title currently playing, press REPEAT a second time.
- → REPEAT TITL appears on the display.
- To repeat the entire disc, press REPEAT a third time.
- → REPEAT appears on the display.
- To exit Repeat mode, press REPEAT a fourth time.

Video CDs - Repeat track/disc

- To repeat the track currently playing, press REPEAT.
- → REPEAT TRK appears on the player display.
- To repeat the entire disc, press REPEAT a second time.
- → REPEAT appears on display and screen.
- To exit Repeat mode, press REPEAT a third time.

Repeat A-B

- To repeat a sequence in a title:
Press REPEAT A-B at your chosen starting point.
- → A- appears briefly on the screen.
- Press REPEAT A-B again at your chosen end point;
- → REPEAT A-B appears briefly on the display, and the repeat sequence begins; (REPEAT A-B is displayed on the front panel of the player)
- To exit the sequence, press REPEAT A-B.

Shuffle

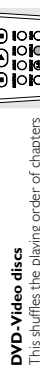

DVD-Video discs

- This shuffles the playing order of chapters within a title, if the title has more than one chapter.
- Press SHUFFLE during playback.
- → SHUFFLE appears on the screen for about 2 seconds.
- To return to normal playback, press SHUFFLE again.

Video CDs

- Press SHUFFLE during playback.
- → SHUFFLE appears on the screen for about 2 seconds.
- To return to normal playback, press SHUFFLE again.

Time search

The Time Search function allows you to start playing at any chosen time on the disc.

- Select ■ (TIME SEARCH) in the menu bar.
- Press ▼.
- → The player will now go into PAUSE mode.
- → A time edit box appears on the screen, showing the elapsed playing time of the current disc.
- Use the digit keys to enter the required start time. Enter hours, minutes and seconds from left to right in the box.
- → Each time an item has been entered, the next item will be highlighted.
- Press OK to confirm the start time.
- → The time edit box will disappear and playback starts from the selected time position on the disc.



Zoom

The Zoom function allows you to enlarge the video image and to pan through the enlarged image.

- Select ■ (ZOOM).
- Press ▲▼ to activate the ZOOM function and select the required zoom factor: 1:33 or 2: or 4.
- → The player will go into Pause mode.
- → The selected zoom factor appears below the Zoom icon in the menu bar and 'Press OK to pan' appears below the menu bar.
- → The picture will change accordingly.
- Press OK to confirm the selection.
- → The panning icons appear on the screen.
- Use the ◀▶▲▼ keys to pan across the screen.
- When OK is pressed only the zoomed picture will be shown on the screen.
- To exit ZOOM mode:
– Press ▶ to resume playback.



FTS-Video

- The FTS-Video function allows you to store your favourite titles and chapters (DVD) and favourite tracks and indexes (VCD) for a particular disc in the player memory.
- FTS programme can contain 20 items (titles, chapters).
- An programmed FTS will be placed on top of the list when playback is activated. When the list is full, a new programme will replace the last programme on the list.
- The programme can be selected and played at any time.

Storing a FTS-Video Programme

- In STOP mode, select **VIDEO FTS**  in the menu bar.
- Press **▼** to open the menu.
- Use **▶** and **◀** to select the required title.
- Press **▶** or **◀** or FTS to select ON or OFF.

Storing titles/tracks

- Press **▼** to select **TITLES**.
- Use **▶** and **◀** to select the required title.
- Press **OK** if you wish to store the entire title.
- → The title number will be added to the list of selections.



Storing chapters/indexes

- Press **▼** on the selected title number.
- → The title number will be marked and the highlight moves to the first available chapter number for this title.
- Use **▶** and **◀** to select the required chapter number.
- Press **OK** to confirm the selection.
- → The title/chapter selection will be added to the list of selections.
- Press SYSTEM MENU to exit the **VIDEO FTS**  menu.

Erasing a FTS-Video Programme

- In STOP mode, select **VIDEO FTS**  in the menu bar.
- Use **▼** to select **PROGRAM**
- Use **▶** and **◀** to select the required selection number.
- Press **OK** to erase the selection.
- Press SYSTEM MENU to exit.

If you wish to erase all selections:

- In STOP mode, select **VIDEO FTS**  in the menu bar.
- Use **▼** to select **CLEAR ALL**
- Press **OK**.
- → All selections will now be erased
- Press SYSTEM MENU to exit.

Special DVD features

Checking the contents of DVD-Video discs: Menu

DVDs may contain menus to navigate the disc and access special features. To use the menu, press the appropriate numerical key or use the **▶**, **▶**, **▶**, **▶** keys to highlight your selection, then press **OK**.

Title/Disc menu

- Press **DISC MENU**
- → If the current title has a menu, the menu will appear on the screen otherwise, the disc menu will be displayed.
- The menu can list camera angles, spoken language and subtitle options, and chapters for the title.
- To remove the title menu, press **DISC MENU** again.

Camera Angle

If the disc contains sequences recorded from different camera angles, the angle icon appears, showing the number of available angles and the angle being shown currently. You can then change the camera angle if you wish.

Use the **▶** **▶** keys to select the required angle icon.

→ After a while, playback changes to the selected angle. The angle icon remains displayed until multiple angles are no longer available.



Changing the audio language

- Select **(i)** **(AUDIO)** in the menu bar.
- Press **(i)** or **▶** repeatedly to see the different languages.



Subtitles

- Select **(S)** **(SUBTITLE)** in the menu bar.
- Press **(S)** or **▶** repeatedly to see the different subtitles.



Special VCD & SVCD features

Playback Control (PBC)

- Load a Video CD with PBC and press **▶**.
- Go through the menu with the keys indicated on the TV screen until your chosen passage starts to playback. If a PBC menu consists of a list of titles, you can select a title directly.
- Enter your choice with the numerical keys (0-9).
- Press **RETURN** to go back to the previous menu.
- You may also set to **PBC OFF** under Personal Preferences.

Playing an audio CD

- After loading the disc, playback starts automatically.
- If the TV is on, the Audio CD screen appears.
- The number of tracks and the total playing time will be shown on the screen.
- During playback, the current track number and its elapsed playing time will be shown on the screen and on the player display.
- Playback will stop at the end of the disc.
- To stop playback at any other time, press **■**.



Pause

- Press **II** during playback.
- To return to playback, press **▶**.



Search

- To search forward or backward through the disc at four times normal speed, hold down **▶** or **▶** for about one second.
- → Search begins, and sound is partially muted.
- To step up to eight times the normal speed, press **▶** or **▶** again.
- → Search goes to eight times the speed, and the sound is muted.
- To return to four times the normal speed, press **▶** or **▶** again.
- If the TV is on, search speed and direction are indicated on the screen each time **▶** or **▶** is pressed.
- To end the search, press **▶** to resume playback or **■** to stop.



Moving to another track

- Press **◀** or **▶** briefly during playback to go to the next or to return to the beginning of the current track.
- Press **◀** or **▶** twice briefly to step back to the previous track.
- To go directly to any track, enter the track number using the numerical keys (0-9).

Shuffle

- Press **SHUFFLE** during playback.
- → The order of the tracks is changed.
- To return to normal playback, press **SHUFFLE** again.



Repeat track/disc

- To repeat the track currently playing, press **REPEAT**.
- → **REPEAT TRK** appears on the display.
- To repeat the entire disc, press **REPEAT** a second time.
- → **REPEAT** appears on the display.
- To exit Repeat mode, press **REPEAT** a third time.



Repeat A-B

- To repeat a sequence:
 - Press **REPEAT A-B** at your chosen starting point;
 - → **A** appears on the player display.
- Press **REPEAT A-B** again at your chosen end point;
- → **A-B** appears on the display, and the sequence begins to playback repeatedly.
- To exit the sequence, press **REPEAT A-B** again.



Scan

- Scanning plays the first 10 seconds of each track on the disc.
- Press **SCAN**.
- To continue playback at your chosen track, press **SCAN** again or press **▶**.



FTS Programme

- FTS Programme allows you to store your favourite tracks for a particular disc in the player memory.
- Each FTS Programme can contain 20 tracks.



Storing an FTS Programme

- 1 Load a disc and stop playback.
- 2 Use **▼** to go to the list of available tracks.
- 3 Use **▶** or **◀** to select tracks from the list. To go directly to any track, enter the track number using the numerical keys (0-9).
- 4 Store each track by pressing **OK**.
 - The track numbers will be added to the list.
 - The number of tracks and the playing time of the programme will be shown on the screen and the player display.

When your FTS Programme is complete, press **▶** to start playback or **▶** to go back to Stop mode. In either case, the FTS Programme will be automatically memorized.

Switching FTS ON/OFF

- 1 Use **▲ ▼** to move to select desired tracks.
- 2 Use **▶** or **◀** to select either ON or OFF.

Erasing a track from an FTS Programme

- 1 Use **▼** to go to the list of selected tracks.
- 2 Use **▶** and **◀** to select the track number you wish to erase. Press **OK**.
- 3 The track number will be erased from the list of selected tracks.

Erasing the complete programme

- 1 Use **▼** to select **CLEAR ALL**, then press **OK**.
 - The complete FTS Programme for the disc will be erased.

MP3 Disc Features (DVD622 only)

Downloading MP3 files from the Internet or ripping songs from your own legal discs, is a delicate process.

Sound Quality	Bit Rate	Approximate MP3 CD time	Approximate total MP3 CD time	Comment
128 kbps	96 kbps	80 min	80 min	Best sound quality, not recommended
160 kbps	112 kbps	64 min	64 min	Best sound quality
192 kbps	128 kbps	51 min	51 min	Best sound quality, compression rate
224 kbps	144 kbps	40 min	40 min	Compression rate low
256 kbps	160 kbps	31 min	31 min	Compress to play, CD instead

As a result, you may experience an occasional "skip" while listening to your MP3 Discs. This is considered to be normal.

Additional note for MP3 Disc Playback:

- In compliance with the SDMI, digital-out is muted while playing MP3 discs.
- It supports sampling frequencies of 48 kHz, 44.1 kHz (preferred) and 32 kHz.
- Due to the recording nature of DAM discs (these are discs containing both Digital Audio and MP3 encoded music), it will only play the Digital Audio music.

Note:

- Only the first session of multiresession discs is supported

Album/Title

This feature allows you to view and select the next or previous MP3 disc Album/Title.

- 1 Press **▲ ▼** to scroll through the previous or next Album.
- 2 Press **▶ ◀** to scroll through the previous or next Track.

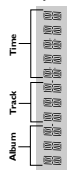

will be displayed.

- 3 You can also select the desired album/track number directly from the numerical key pad on the remote control.

Note:

- In **STOP** mode, numbers are used for ALBUM selection.
- In **PLAY** mode, numbers are used for TRACK selection.

- Only the following modes are possible for MP3 discs:
 - STOP / PLAY / PAUSE
 - SKIP NEXT / PREVIOUS
 - REPEAT (ALBUM / TRACK / DISC)

MP3 Discs - Album/Track/Disc

- To repeat track, press **REPEAT**.
 - **REPEAT TRK** appears on the display.
- To repeat album, press **REPEAT** a second time.
 - **REPEAT ALB** appears on the player display.
- To repeat disc, press **REPEAT** a third time.
 - **REPEAT DISC** appears on the player display.

Access Control

Access Control; Child Lock (DVD-Video and Video CD)

Activating/deactivating the child lock

- 1 When disc playback is stopped, select **ACCESS CONTROL** in the features menu using the **▲ ▼** keys.
- 2 Enter a 4-digit code of your own choice.
- 3 Enter the code a second time.
- 4 Move to **"CHILD LOCK"** using the **▲ ▼** keys.
- 5 Move to **LOCK/UNLOCK** using the **▶** key.
- 6 Select **LOCK** using the **▲ ▼** keys.
- 7 Press **OK** or **◀** to confirm, then press **◀** again to exit the menu.
 - Now unauthorized discs will not be played unless the 4-digit code is entered.
- 8 Select **UNLOCK** to deactivate the **CHILD LOCK**.
 - The code is entered for the very first time (see above).
 - The code is changed (see "Changing the 4-digit code").
 - The code is cancelled (see "Changing the 4-digit code").

Access control; Parental Control (DVD-Video only)

Movies on DVDs may contain scenes not suitable for children. Therefore, disc may contain Parental Control information which applies to the complete disc or to certain scenes on the disc. These scenes are rated from 1 to 8, and alternative, more suitable scenes are available on the disc. Ratings are country dependent. The Parental Control feature allows you to prevent discs from being played by your children or to have certain discs played with alternative scenes.



Authorizing discs

- Insert the disc. See 'Loading disc'.
 - The 'child protect' dialog will appear. You will be asked to enter your secret code for 'Playback Once' or 'Playback Always'. If you select 'Playback Once', the disc can be played as long as it is in the player and the player is ON. If you select 'Playback Always', the disc will become child safe (authorized) and can always be played, even if the Child Lock is set to ON.

Notes:

- The player memory maintains a list of 120 authorized ('Child safe') disc titles. A disc will be placed in the list when 'Playback Always' is selected in the 'child protect dialog'.
- Each time a 'child safe' disc is played, it will be placed on top of the list. When the list is full and a new disc is added, the last disc in the list will be removed from the list.
- Double sided DVDs may have a different ID for each side. In order to make the disc 'child safe', each side has to be authorized.
- Multi-volume VCDs may have a different ID for each volume. In order to make the complete set 'child safe', each volume has to be authorized.



Deauthorizing discs

- Insert the disc. See 'Loading disc'.
 - Playback starts automatically.
- Press **■** while **Ⓢ** is visible.
 - The **Ⓢ** will appear and the disc is now deauthorized.



Before Requesting Service

If it appears that the DVD-Video player is faulty, first consult this checklist. It may be that something has been overlooked. Under no circumstances attempt to repair the system yourself; this will invalidate the warranty.

Look for the specific symptom(s). Then perform only the actions listed to remedy the specific symptom(s).

Symptom	Remedy
No power	<ul style="list-style-type: none"> Make sure the mains cord (AC Power) is properly connected. Check if there is power at the AC outlet by plugging in another appliance.
No picture	<ul style="list-style-type: none"> Check if the TV is switched on. Check the video connection.
Distorted picture	<ul style="list-style-type: none"> Check the disc for fingerprints and clean the disc with a soft cloth, wiping from the centre to the edge in a straight line. Sometimes a small amount of picture distortion may appear. This is not a malfunction.
Completely distorted picture or no colour with player menu.	<ul style="list-style-type: none"> If the picture is distorted completely or if the picture rolls vertically, make sure the NTSC/PAL setting at the DVD player matches the video signal of your television. If your TV video signal is NTSC, select the NTSC setting at the DVD player. If your video signal is PAL, select the PAL setting - see NTSC/PAL SETTINGS.
Distorted or Black/White picture with DVD or Video CD.	<ul style="list-style-type: none"> The disc format does not match your TV's video signal (PAL/NTSC) - see NTSC/PAL Conversion.
No sound	<ul style="list-style-type: none"> Check audio connections. If you are using a HiFi amplifier, try another sound source.
Distorted sound from HiFi amplifier.	<ul style="list-style-type: none"> Check to make sure that no audio connections are made to the amplifier phono input.
No audio at digital output.	<ul style="list-style-type: none"> Check the digital connections. Check the settings menu to make sure the digital output is set to ALL or PCM. Check if the audio format of the selected audio language matches your receiver capabilities. Not applicable for MP3
Disc can't be played.	<ul style="list-style-type: none"> Ensure the disc label is facing up. Clean the disc. Check if the disc is defective by trying another disc. Check to see if the disc is defective, badly scratched or warped (not flat)
No return to start-up screen when disc is removed.	<ul style="list-style-type: none"> Reset by switching the player off, then on again. Check to see if the programme requires another disc to be loaded.
The player does not respond to the remote control.	<ul style="list-style-type: none"> Aim the remote control directly at the sensor on the front of the player. Remove any obstacles between the player and the remote control. Inspect or replace the batteries in the remote control.
Buttons do not work.	<ul style="list-style-type: none"> In order to completely reset the player, unplug the AC cord from the AC outlet. (Please ensure that the set is not in Initial Setup mode)
Player does not respond to some operating commands during playback.	<ul style="list-style-type: none"> Operations may not be permitted by the disc. Refer to the instructions of the disc.
DVD-Video player cannot read CDs/DVDs	<ul style="list-style-type: none"> Use a commonly available cleaning CD/DVD to clean the lens before sending the DVD-Video player for repair.

Activating/Deactivating Parental Control

- When disc playback is stopped, select **ACCESS CONTROL** in the features menu using the **▲▼** keys.
- Enter your 4-digit code. If necessary, enter the code a second time.
- Move to **Parental Control** using the **▲▼** keys.
- Move to **VALUE ADJUSTMENT** (1-8) using the **▶** key.
- Then use the **▲▼** keys or the numerical keys on the remote control to select a rating from 1 to 8 for the disc inserted.

Rating 0 (displayed as "-"):

Parental Control is not activated. The Disc will be played in full.

Ratings 1 to 8:

The disc contains scenes not suitable for children. If you set a rating for the player, all scenes with the same rating or lower will be played. Higher rated scenes will not be played unless an alternative is available on the disc. The alternative must have the same rating or a lower one. If no suitable alternative is found, playback will stop and the 4-digit code has to be entered.

- Press **OK** or **▶** to confirm, then press **◀** again to exit the menu.



Country

- When disc playback is stopped, select **ACCESS CONTROL** in the features menu using the **▲▼** keys.
- Enter the 4-digit code.
- Move to **CHANGE COUNTRY** using the **▼** key.
- Press the **▶** key.
- Select a country using **▲▼**.
- Press **OK** or **▶** to confirm, then press **◀** again to exit the menu.

Changing the 4-digit code

- When disc playback is stopped, select **ACCESS CONTROL** in the features menu using the **▲▼** keys.
- Enter the old code.
- Move to **CHANGE CODE** using the **▼** key.
- Press the **▶** key.
- Enter the new 4-digit code.
- Enter the code a second time and reconfirm by pressing **OK**.
- Press **◀** to exit the menu.

If you forget your 4 digit code

- Press **■** to exit 'Child Protect' screen.
- Select **ACCESS CONTROL** in the features menu using the **▲▼** keys.
- The 4-digit code can be cancelled by pressing **■** four times in the 'Access Control' dialog.
- You can then enter a new code (twice) as described above (Changing the 4 digit code).

Parental Control Disclaimer

This DVD player features the **PARENTAL CONTROL** system which is intended to activate when playing DVD discs furnished with certain software coding. This is according to technical standards adopted by the set maker and disc content industries.

Please note that the **PARENTAL CONTROL** system will not operate a DVD disc which is not furnished with the appropriate software coding. Also note that at the time of release of this DVD player certain aspects of the technical standards had not been settled between set makers and the disc industries.

On this basis Philips cannot guarantee the functioning of **PARENTAL CONTROL** system and denies any liability associated with unintended watching of disc content. If in doubt, please make sure the disc plays according to your **PARENTAL CONTROL** settings before you allow children access to the player.

4. Mechanical instructions

4.1 Dismantling instructions

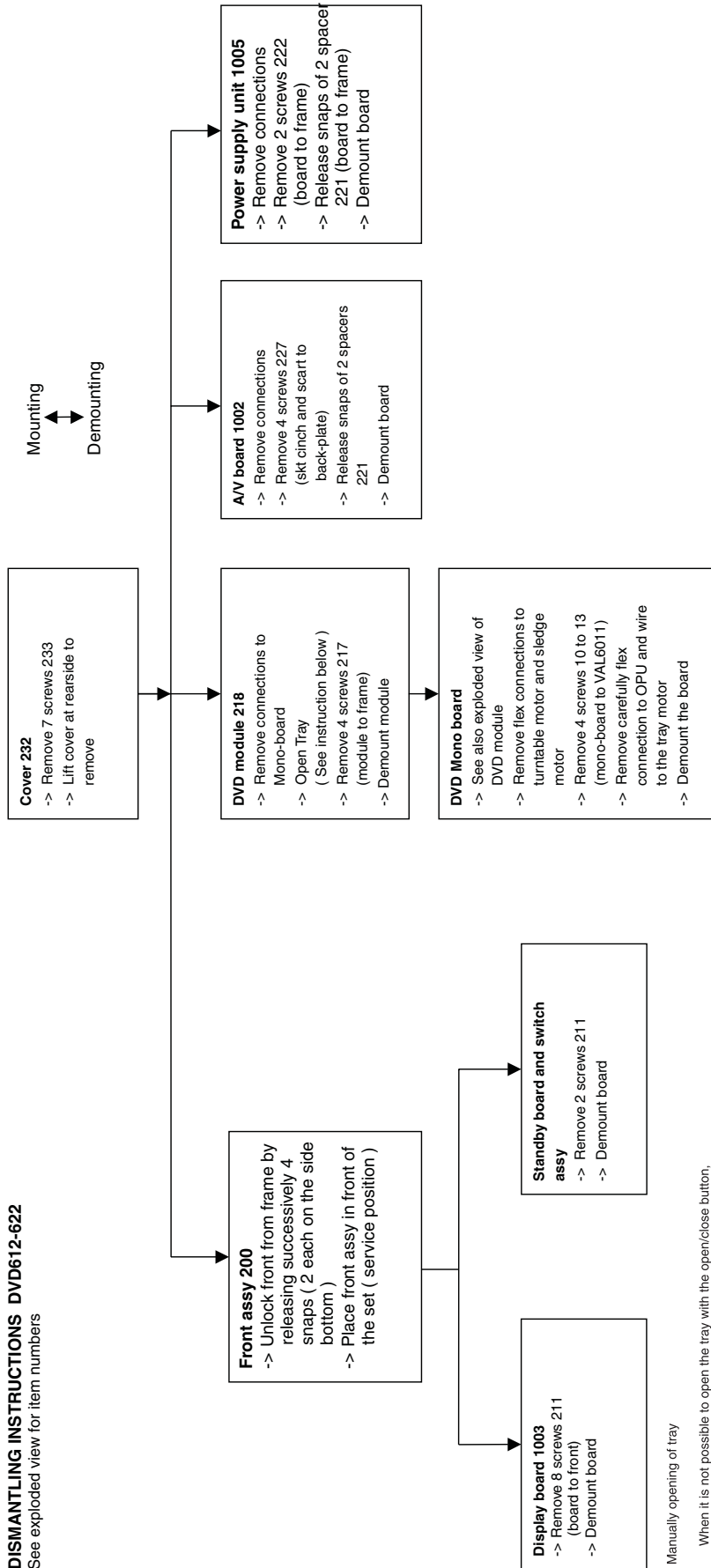

DISMANTLING INSTRUCTIONS DVD612-622
See exploded view for item numbers

Manually opening of tray

When it is not possible to open the tray with the open/close button, the tray can manually be opened.
When no disc is loaded, unlock the tray by moving the slide from the left to the right and pull tray outwards.

When a disc is loaded, unlock the tray by pushing the slide inwards by way of a screwdriver and pull tray outwards.

Remove 4 screws to remove loader.

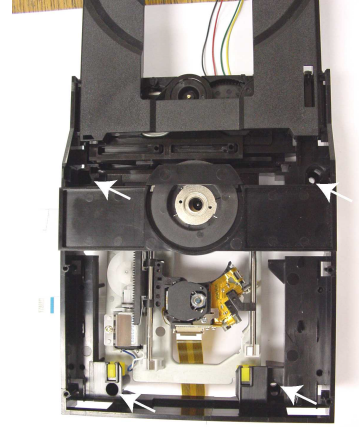
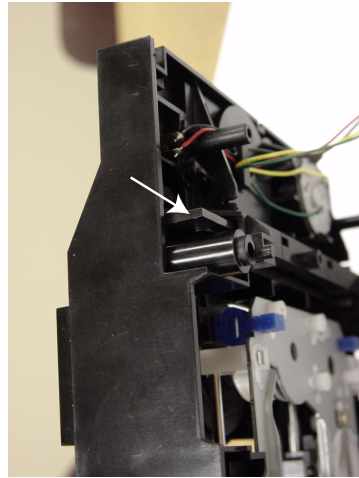
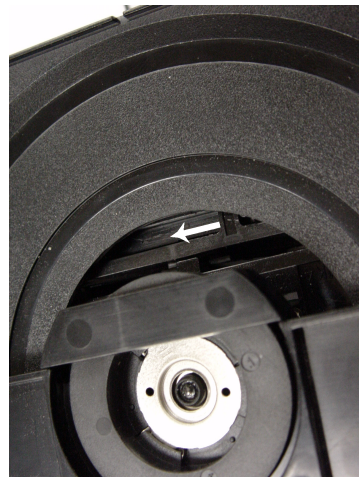

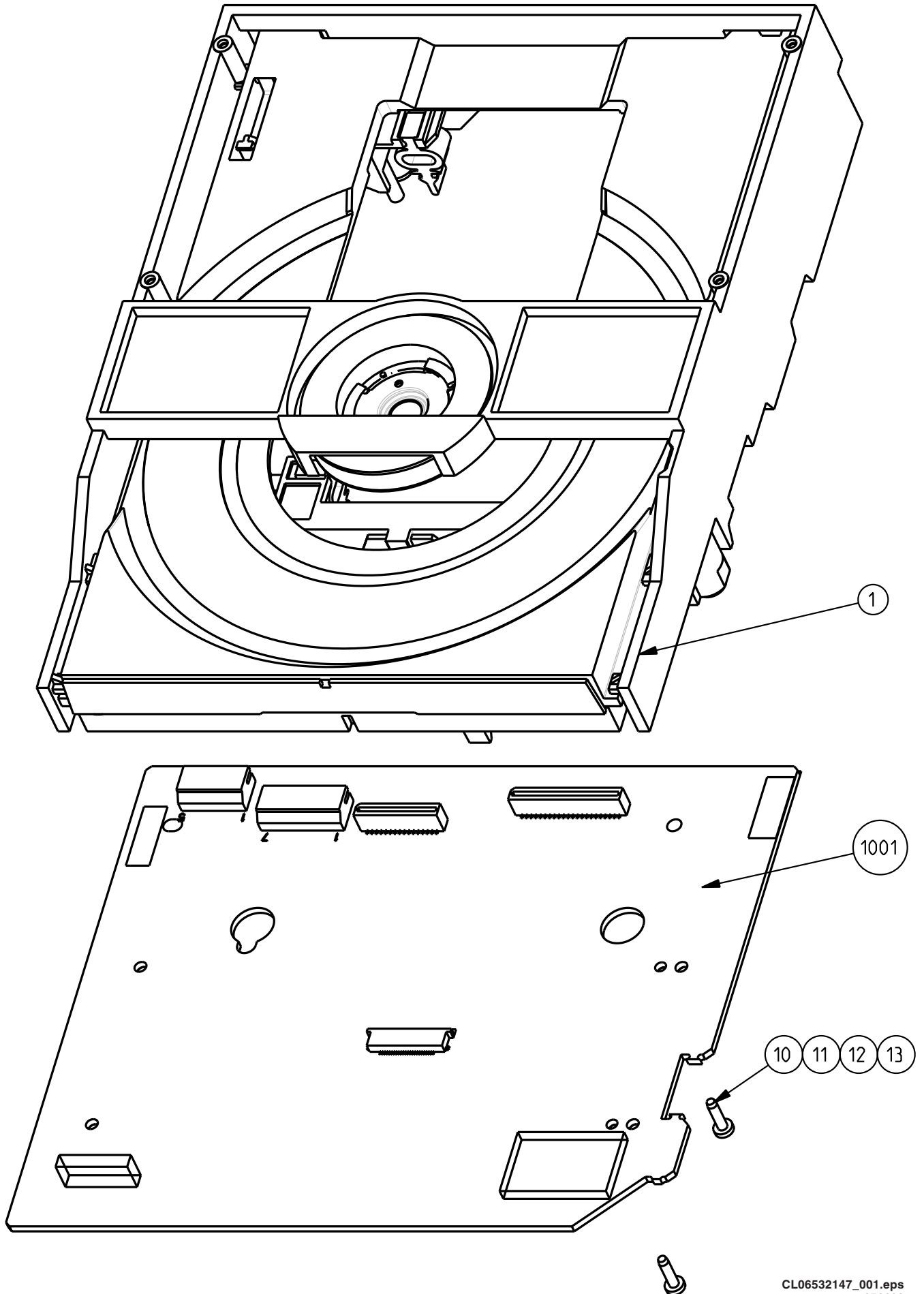

4.2 Exploded views

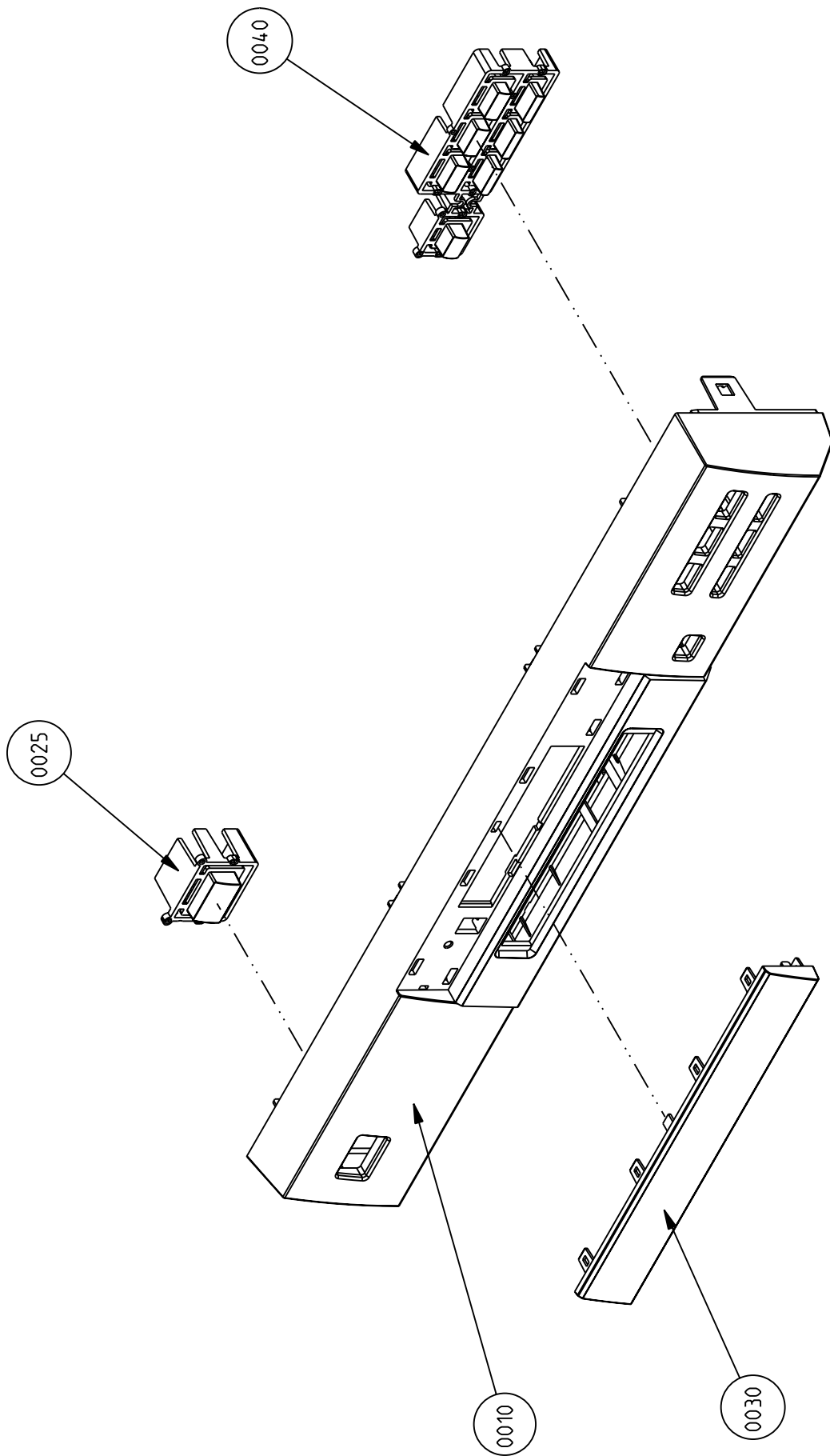

CL 16592007_028.eps
020201

NUMBER IN CIRCLE CORRESPOND TO ITEM NUMBER IN P/L

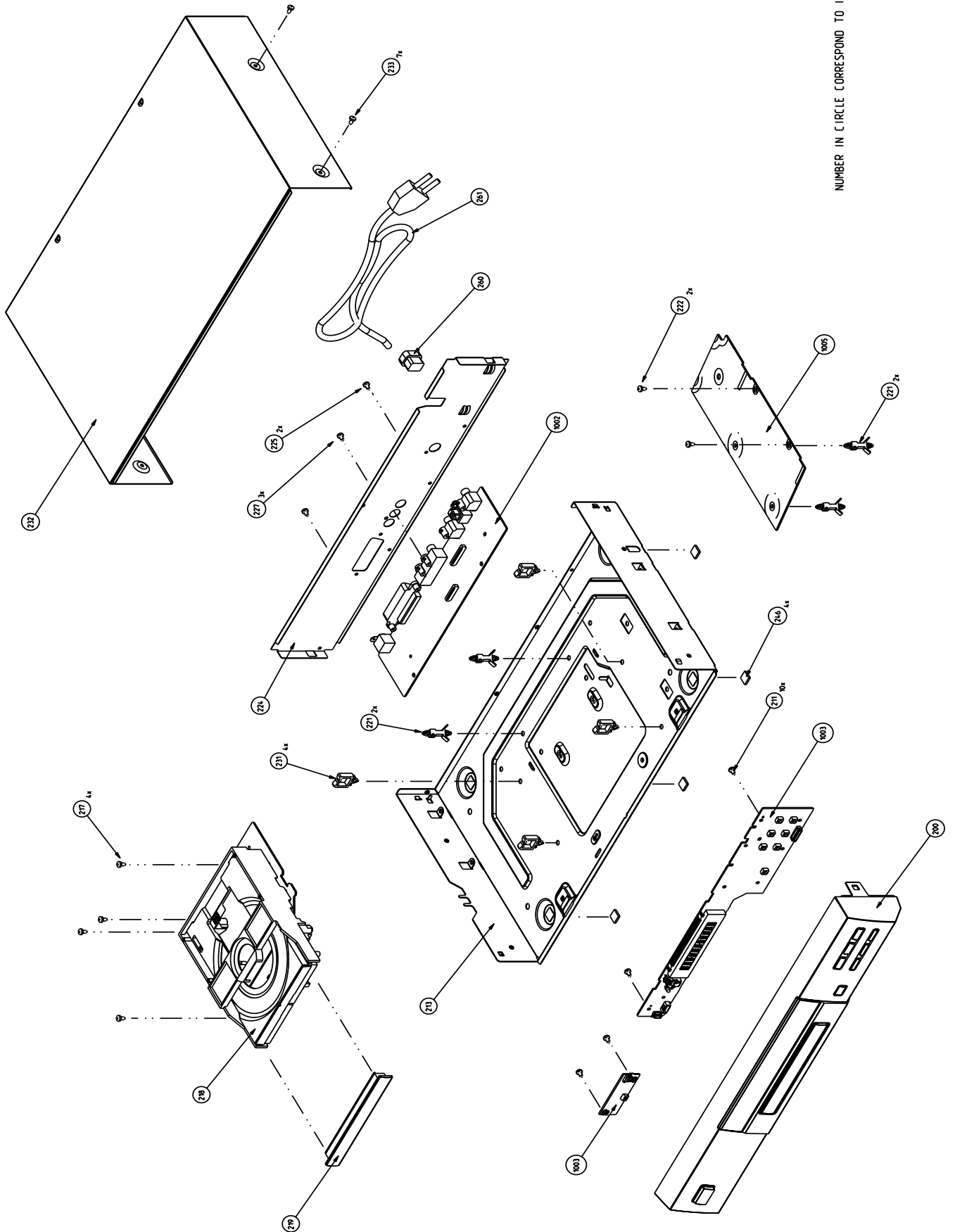

NUMBER IN CIRCLE CORRESPOND TO ITEM NUMBER IN P/L

4.3 Service position

See figure 4-1 for the service position

1. Remove the cables from the cable tie housing.
2. Remove 4 screws that mount the DVD module to the bottom frame.
3. Move the DVD module backward slightly and flip the module over, so that the component side of the board faces upwards, and the module is in the service position.

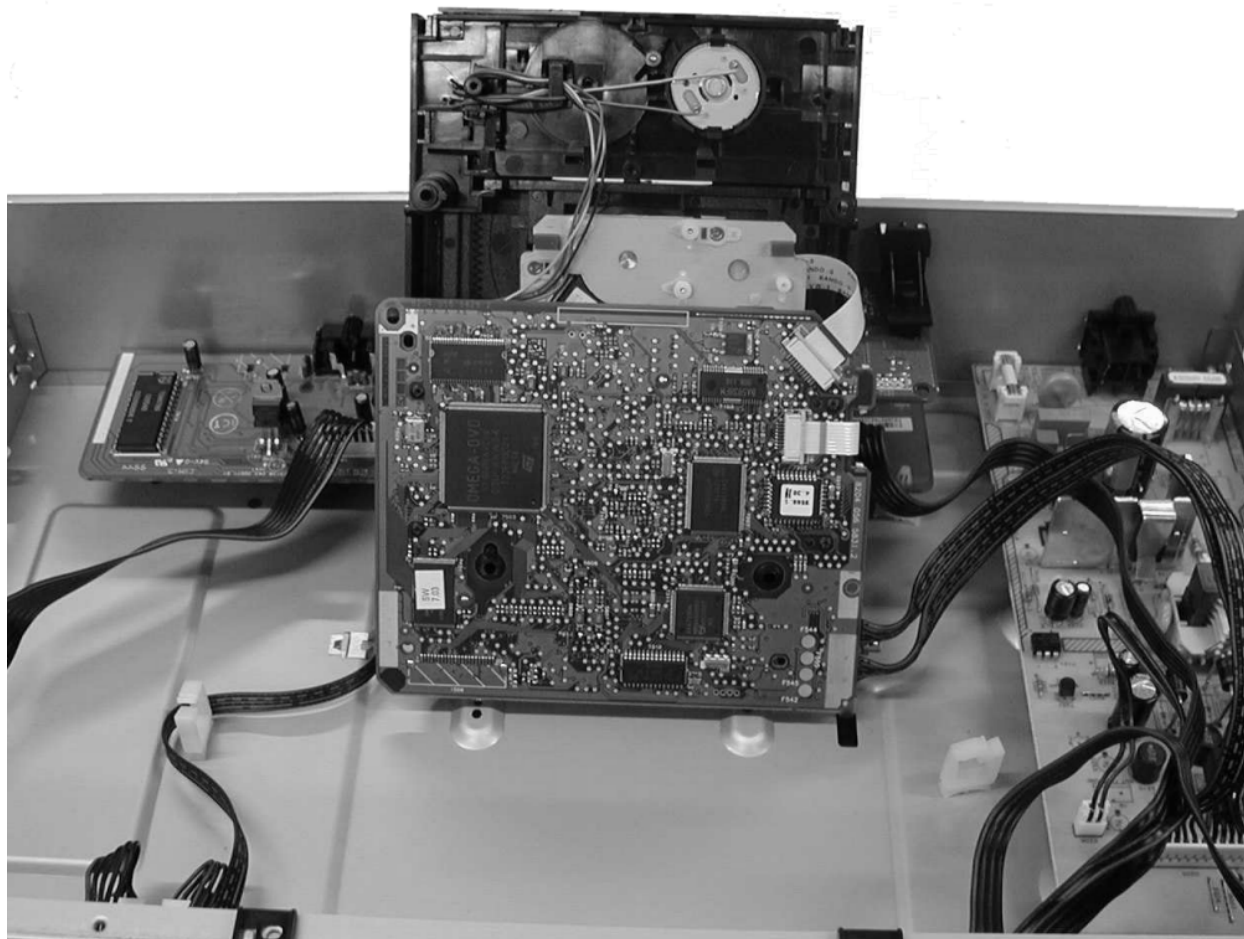

Figure 4-1

5. Diagnostic software descriptions and troubleshooting

5.1 Dealerscript

5.1.2 Contents of Dealer Script

5.1.1 Purpose of Dealer Script

The dealer script can give a diagnosis on a standalone DVD player; no other equipment is needed to perform a number of hardware tests to check if the DVD player is faulty. The diagnosis is simply a "error" or "pass" message; no indication is given of faulty hardware modules. Only tests within the scope of the diagnostic software will be executed hence only faults within this scope can be detected.

The dealer script executes all diagnostic nuclei that do not need any user interaction and are meaningful on a standalone DVD player.

The nuclei called in the dealer script are the following (the number after each nucleus name corresponds with the number being on the local display when the nucleus is executed during the dealer script):

Nucleus		Description
VideoColSetupComm	7	Checks the I2C interface with the RGB video processor on the Audio/Video board (only for DVD players with RGB video processor).
PapChksFl	6	Calculate and verify checksum of FLASH memory.
PapI2cDisp	5	Checks the I2C interface with the slave processor on the display PCB.
PapS2bEcho	4	Checks the I2C interface to the basic engine.
PapI2cNvram	3	Checks the I2C interface with the NVRAM.
PapNvramWrR	2	Pattern test of all locations in the NVRAM
CompSdramWrR	1	Pattern test of all locations in the SDRAM(s).

CL06532096_001.eps
050700

Figure 5-1

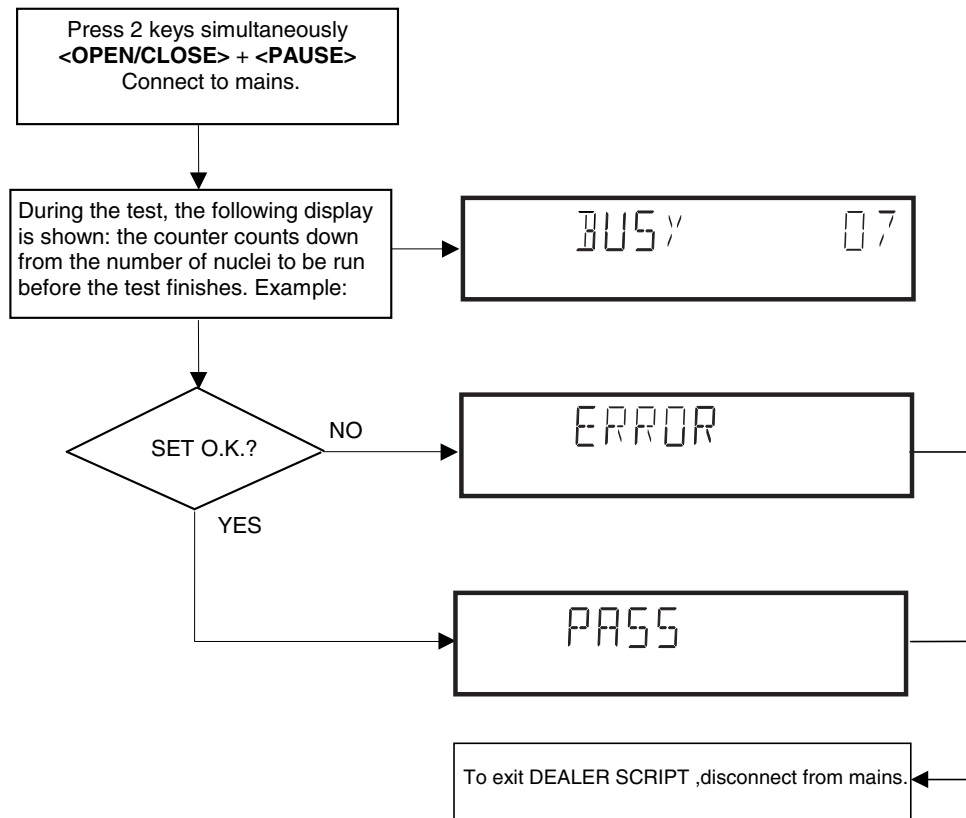

CL 96532065_004.eps
120799

Figure 5-2

5.2 PLAYER SCRIPT

5.2.1 Purpose of Player Script

The Player script will give the opportunity to perform a test that will determine which of the DVD player's modules are faulty, to read the error log and error bits and to perform an endurance loop test. To successfully perform the tests, the DVD player must be connected to a tv set to check the output of a number of nuclei. For DVDv2b a multi-channel amplifier, a set of 6 boxes and an external video source are necessary to test. To be able to check results of certain nuclei, the player script expects some interaction of the user (i.e. to approve a test picture or a test sound). Some nuclei (e.g. nuclei that test functionality of the Basic Engine module) require that the DVD player itself is opened, to enable the user to observe moving parts and approve their movement visually. Only tests within the scope of the diagnostic software will be executed hence only faults within this scope can be detected.

5.2.2 Contents of Player Script

The player script contains all nuclei that are useful on a DVD player that is connected to a tv-set and help to determine which module of the DVD player is faulty, as well as to read out the contents of the error logs.

5.2.3 Structure of Player Script

The player script consists of a set of nuclei testing the three hardware modules in the DVD player: the Display PWB, the Digital PWB and the Basic Engine.

Nuclei run by the player test need some user interaction; in the next paragraph this interaction is described. The player test is done in two phases:

1. Interactive tests: this part of the player test depends strongly on user interaction and input to determine nucleus results and to progress through the full test. Reading the error log and error bits information can be useful to determine any errors that occurred recently during normal operation of the DVD player.
2. The loop test will loop through the list of nuclei indefinitely, till the NEXT key is pressed. The list of nuclei is as follows:
 - VideoColSetupComm
 - VideoScartSwComm
 - PapChksFlash
 - Papl2cNvram
 - CompSdramWrR
 - PapS2bEcho
 - Papl2cDisp

For DSW version 1.6 and above, the DSW version number will be displayed on the local display. Press NEXT to continue to the display test.

The display should look like the following:



Figure 5-3

5.2.4 Survey

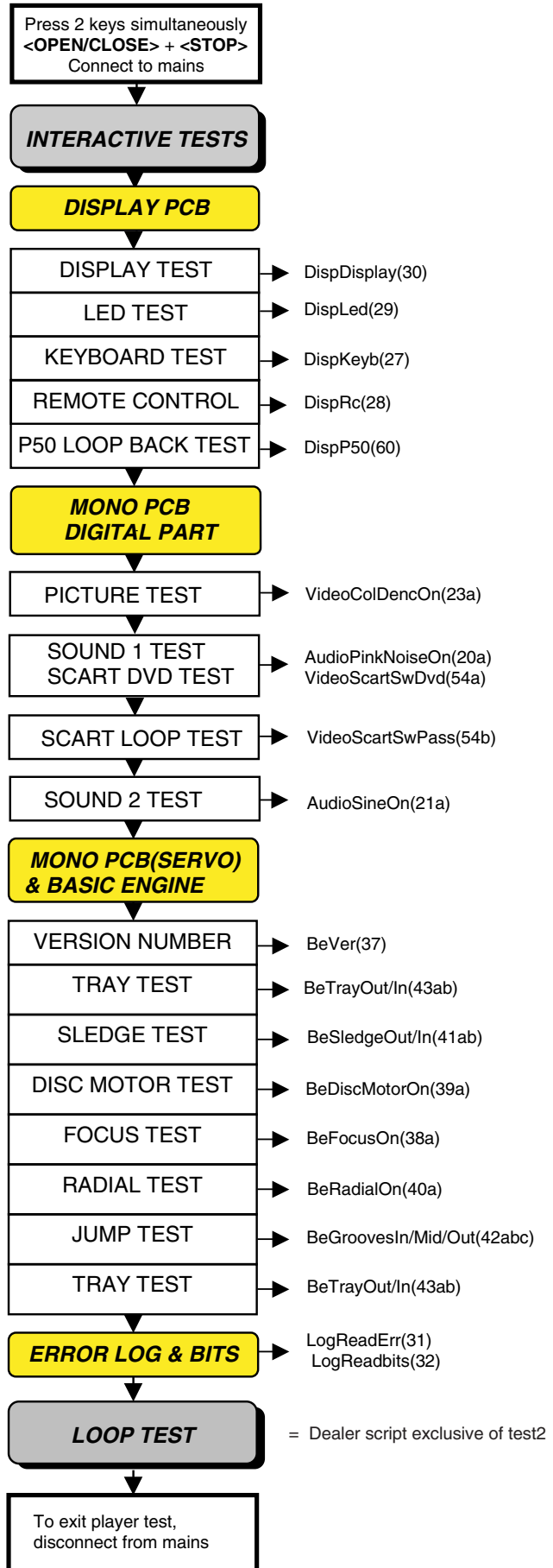

Figure 5-4

5.3 DISPLAY PCB

5.3.1 DISPLAY TEST

The display test is performed by nucleus DispDisplay. By putting a series of test patterns on the local display, the local display is tested. To step through all different patterns, the user must either press PLAY (pattern is ok) or PAUSE (pattern was incorrect) to proceed to the next pattern. The display of patterns is continued in a cyclic manner until the user presses NEXT. If the user presses NEXT before all display patterns are tested, the DispDisplay nucleus will return TRUE (display test successful).

5.3.2 LED TEST

The LED(s) on the DVD player is (are) tested by nucleus DispLed. The user must check if the LED(s) is (are) lighted; if it is, press PLAY, if it is not, press PAUSE. By pressing NEXT the script will proceed to the next test. If the user presses NEXT before PLAY or PAUSE, the DispLed nucleus will return TRUE (LED test successful).

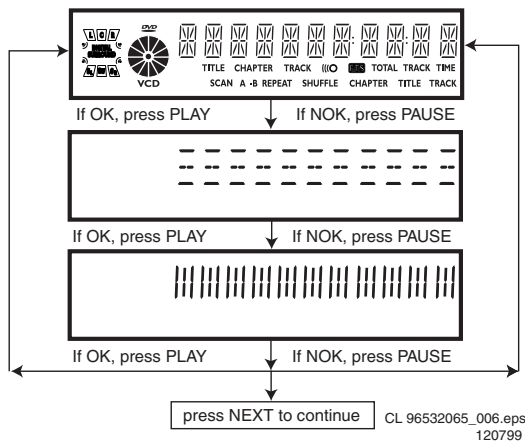

Figure 5-5

5.3.3 KEYBOARD TEST

The keyboard of the DVD player is tested by nucleus DispKeyb. The user is expected to press all keys on the local keyboard once. The code of the key pressed is shown on the local display (1 hexadecimal digit) immediately followed by a (hexadecimal) number indicating how many times that key has been pressed. Example of the local display during this test:

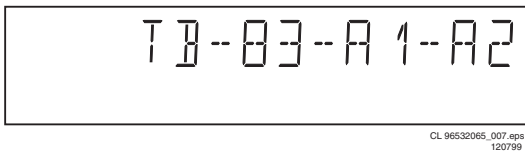

Figure 5-6

The key-codes displayed on the local display will scroll from right to left when the display gets full, the text "tb-" will remain on display.

key id.	key
0	PLAY
1	NEXT
2	PREVIOUS
3	PAUSE
4	STOP
5	OPEN/CLOSE
6	3D-SURROUND
7	KEY- (Mic Control)
8	Once More (Mic Control)
9	KEY+(Mic Control)
A	STAND BY

CL16532007_007.eps
300101

Figure 5-7

If any keys are detected more than once (due to hardware error), the key-code is displayed twice (or more), with the second digit increased by 1. If the user does not press all keys minimally once (in any order), the DispKeys nucleus will return FALSE and cause an error in the overall result of the player script. The test will also pass if all buttons, except the microphone key buttons, are pressed. The user can leave the keyboard test by pressing the NEXT key on the local display of the DVD player for at least one full second. The result of the keyboard test is shown on local display as follows:

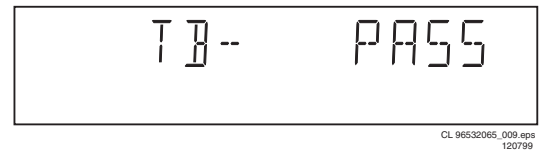

CL 96532065_009.eps
120799

Figure 5-8

Or

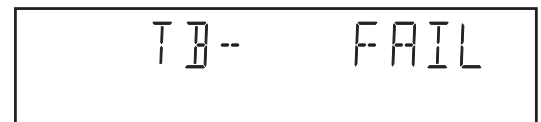

CL 96532065_010.eps
120799

Figure 5-9

Pressing NEXT on the local keyboard again will proceed to the next text.

5.3.4 REMOTE CONTROL TEST

The remote control of the DVD player is tested by nucleus DispRc. The user must press any key on the remote control just once. The codes of the key pressed will be shown on the local display in hexadecimal format. Example:

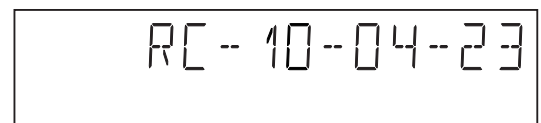

CL 96532065_011.eps
120799

Figure 5-10

In this example 23 is the hexadecimal code of the pressed RC key. The user can leave the remote-control test by pressing NEXT on the local keyboard of the DVD player. The remote

control test is successful if a code was received before the user pressed the NEXT key; pressing the NEXT key before pressing a key on the remote control gives an error in the remote control test (note that the remote control test will also fail if a key on the remote control was pressed but no code was received). The remote control test does not check upon the contents of the received code, that is it will not be checked if the received code matches the key pressed. If desired, the user can manually check this code by using a code-table for the remote control key-codes.

C Key id	Hexadecimal code
STANDBY	0C
STOP	31
PLAY	2C
PLAY BACKWARD	2D
PAUSE	30
STEP FORWARD	F6
STEP BACKWARD	F5
FORWARD	28
FORWARD 4X	DF
FORWARD 8X	E0
BACKWARD	29
BACKWARD 4X	DE
BACKWARD 8X	DD
SLOW	22
SLOW 2	D9
SLOW BACKWARD	23
SLOW BACKWARD 2	DA
NEXT	20
PREVIOUS	21
CURSOR UP	58
CURSOR DOWN	59
CURSOR LEFT	5A
CURSOR RIGHT	5B
OK	5C
0	0
1	1
2	2
3	3
4	4
5	5
6	6
7	7
8	8
9	9
TOGGLE	C8
ANGLE	85
AUDIO	4E
SUBTITLES	4B
SUBTITLE ON/OFF	E3
ROOT MENU	54
TITLE MENU	71
MENU	D1
SETUP MENU	82
OSD ON/OFF	F
RETURN	83
RESUME	D7
SCAN	2A
SHUFFLE	1C
REPEAT	1D
A/B REPEAT	3B
TOGGLE SCART	43
OPEN/CLOSE	42
FTS	FB
KARAOKE	E4
OPTION	FA

CL06532096_003.eps
050700

Figure 5-11

After pressing NEXT, the result of the remote control test is displayed on the local display of the DVD player as follows:

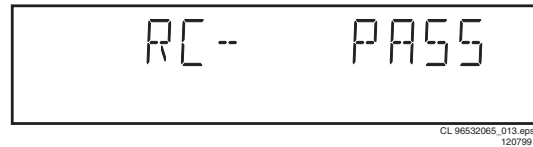

Figure 5-12

Or



Figure 5-13

Pressing NEXT on the local keyboard again will proceed to the next test.

5.3.5 P50 LOOP-BACK TEST

For the P50 loop-back test, the user must first press a key to decide if the test is to be performed. The display will show the following message:



Figure 5-14

If the user presses PAUSE, the P50 test will be skipped. If the user presses PLAY, the P50 test is performed and the result is displayed as follows:

Test successful:

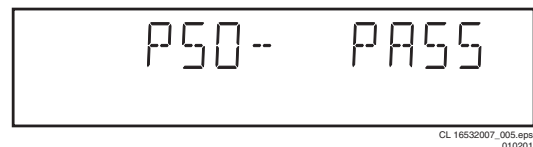

Figure 5-15

Test fails:

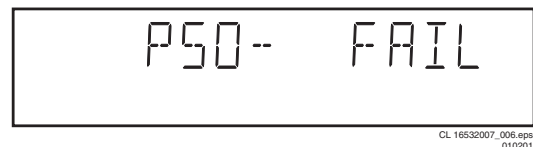

Figure 5-16

Press the NEXT key to continue to the next text

5.4 MONO PCB DIGITAL PART

5.4.1 PICTURE TEST

The picture test is performed by putting a predefined picture (colour bar) on the display (nucleus VideoColDencOn) and

asking the user for confirmation. The display will show the following message:



Figure 5-17

By pressing PLAY the user confirms the test, pressing PAUSE will indicate the picture was invisible or incorrect. Pressing NEXT will proceed to the next test

5.4.2 SOUND 1 & SCART DVD TEST

The first soundtest is performed by starting a pink noise sound that needs confirmation from the user (nucleus AudioPinkNoiseOn); the display will show the following message very shortly:



Figure 5-18

This sound will only be audible from version cut3.1 of Sti5505(item7503 on mono board) onwards. After starting up sound 1, SCART loop-trough will be simultaneously active during this test. SCART loop-trough will be measured with the aid of an external video source.

When entering the SCART loop-trough, the local display indicates:



Figure 5-19

On the TV screen a colour bar (generated by nucleus VideoColDencOn) is visual and the internally generated pinknoise is audible. By pressing PLAY the user confirms the test, pressing PAUSE will indicate the sound was inaudible or incorrect. Pressing NEXT will proceed to the next test; if the user presses NEXT without pressing PLAY or PAUSE first, the result of this test will be TRUE (sound ok). By pressing the NEXT button there will be switched over to the external source, this must become now visible on the TV screen (using the SCART). The local display indicates:



Figure 5-20

The internally generated colour bar is still available on the CVBS and Y/C outputs. And the pinknoise-signal is still available on the cinch audio outputs. By pressing the PREV button, the internal generated colour bar becomes visual again.

The test can be left by pressing the NEXT key for more than one second.

5.4.3 SOUND 2 TEST

The second soundtest is performed by producing a sine sound (nucleus AudioSineOn). The signal can be stopped by pressing the STOP-key. The display will show the following message:

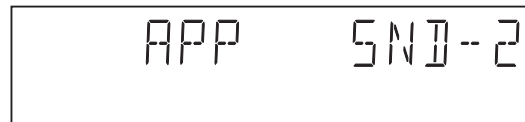

Figure 5-21

By pressing PLAY the user confirms the test, pressing PAUSE will indicate that something went wrong. Pressing NEXT will proceed to the next; if the user presses NEXT without pressing PLAY or PAUSE first, the result of this test will be TRUE (sound ok).

5.4.4 Colour setup test

The colour setup test is performed by putting the internally generated colour bar in different settings on the TV screen. The first colour bar will be displayed in setting 1. the display will show the following message:



Figure 5-22

By pressing the NEXT button, you can go to the second setting. The local display indicates:

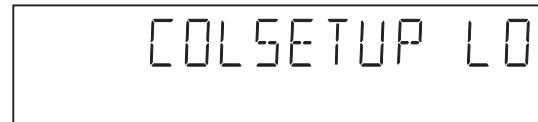

Figure 5-23

By pressing the PREVIOUS button, the colour bar with the first setting becomes visual again. By pressing PLAY the user confirms the test, pressing PAUSE will indicate that something went wrong. The test can be left by pressing the NEXT key for more than one second; if the user presses NEXT without pressing PLAY or PAUSE first, the result of the test will be TRUE (colour set-up ok).

5.5 BASIC ENGINE

5.5.1 VERSION NUMBER

In the basic engine tests, the version number of the Basic Engine will be shown first, as the following example:

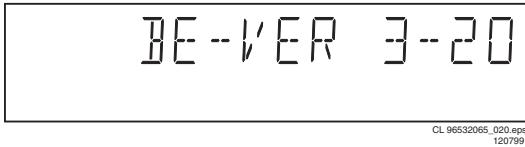

Figure 5-24

By pressing the NEXT key, the Basic Engine tests are started.

5.5.2 TRAY TEST

First, the tray is tested. The purpose of this test is also to give the user the opportunity to put a disc in the tray of the DVD player. Some tests on the Basic Engine require that a disc (e.g. DVD MPTD test disc) is present in the player. At the end of the Basic Engine tests this tray test will be repeated solely to enable the user to remove the disc in the tray. The local display will look as follows:

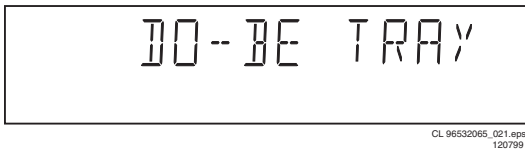

Figure 5-25

By pressing PLAY or PAUSE the user can toggle the position of the tray. Note that this test will not contribute to the test result of the Basic Engine. Pressing NEXT will proceed to the next test, after the tray has been closed (by the software) if it was open.

5.5.3 SLEDGE TEST(visual test)

The second Basic Engine test tests the sledge; the user can move the sledge as many times as desired by using PLAY (nucleus BeSledgeOut) and PAUSE (nucleus BeSledgeIn). Pressing NEXT on the local keyboard proceeds to the next test. Note that this test will not contribute to the test result of the Basic Engine. The local display will look as follows during the sledge test:

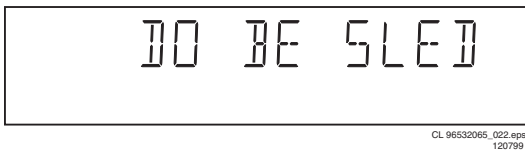

Figure 5-26

5.5.4 DISC MOTOR TEST(visual test)

The third Basic Engine test tests the disc motor (nucleus BeDiscMotorOn); the local display looks as follows:

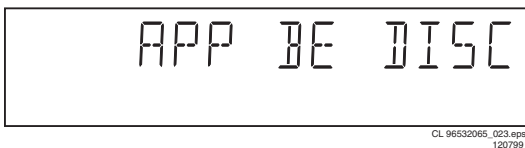

Figure 5-27

By pressing PLAY the user confirms that the disc motor is running; pressing PAUSE indicates the disc motor does not work. Pressing NEXT proceeds to the next test, after a reset

of the disc motor (nucleus BeDiscMotorOff). If the user presses NEXT before pressing PLAY or PAUSE, the result of this test will be TRUE (disc motor is running).

5.5.5 FOCUS TEST(visual test)

The fourth Basic Engine test tests the focussing; first focussing is turned on by calling nucleus BeFocusOn. The display will look as follows:

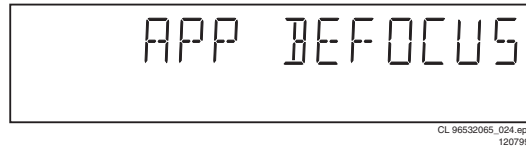

Figure 5-28

By pressing PLAY the user confirms that the focussing was successful; pressing PAUSE indicates a focussing failure. Pressing NEXT proceeds to the next test after a reset of the focussing (nucleus BeFocusOff); if NEXT is pressed before PLAY or PAUSE, the result of this test will be TRUE (focus successful).

5.5.6 RADIAL TEST(visual & listening test)

The fifth Basic Engine test tests the radial functionality (nucleus BeRadialOn); the local display looks as follows:

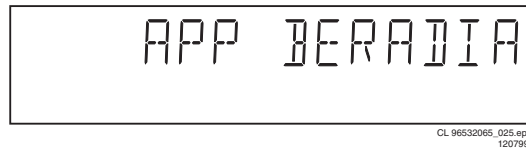

Figure 5-29

By pressing PLAY the user confirms that the radial function worked; pressing PAUSE indicates the function does not work. Pressing NEXT proceeds to the next test, after a reset of the radial (nucleus BeRadialOff). If the user presses NEXT before pressing PLAY or PAUSE, the result of this test will be TRUE (radial successful).

5.5.7 JUMP TEST(listening test)

The sixth and last Basic Engine test tests the jumping by calling nuclei BeGroovesIn, BeGroovesMid and BeGroovesOut. During this test, the local display looks as follows:

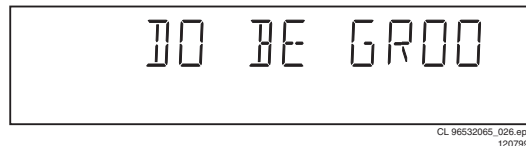

Figure 5-30

The user can switch between the three different types of groove settings by pressing PLAY (forward to next nucleus in the list In-Mid-Out) or PAUSE (backward in the list In-Mid-Out). This is done in a cyclic manner; note that this test will not contribute to the test result of the Basic Engine. Pressing NEXT proceeds to the next test, after the disc motor has been shut off with a call to nucleus BeDiscMotorOff.

5.5.8 TRAY TEST

As a last action for the Basic Engine tests, the tray test is repeated. The local display will look as follows:

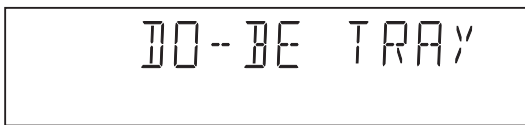

Figure 5-31

This test is meant to give the user the opportunity to remove the disc in the tray. The tray position can be toggled using the PLAY and PAUSE key. The tray will be closed (by the software, if it is open) before proceeding to the next test when the user presses the NEXT key.

5.5.9 ERROR LOG (see table on page 30)

Reading the error log and error bits information can be useful to determine any errors that occurred recently during normal operation of the DVD player. Reading the error log is done by nucleus LogReadErr. The display during the errorlog readout looks as follows :

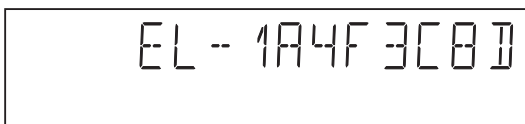

Figure 5-32

By pressing PLAY or PAUSE the user can move forward or backward (respectively) through the logged error codes. The highlighted number indicates which errorcode is currently on display (in the example above, errorcode number 4 is displayed). If "0000" is displayed at all positions, the error log is empty. Display of the logged errors is done in a cyclic manner. The errorcode with the lowest highlighted number is the most recent. By pressing NEXT on the local keyboard, the user can proceed to the next test.

5.5.10 ERROR BITS (see table on page 30)

Reading the error bits is done by nucleus LogReadBits. The display during the errorbits readout looks as follows:

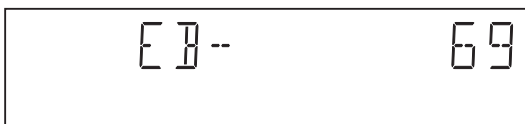

Figure 5-33

Only the set errorbits will be shown by their (decimal) number. Refer to the appropriate documentation for the explanation of each bit number. If the display only shows "EB-0", no error bits were set. By pressing NEXT the user can continue to the next test.

5.6 LOOP TEST (see table below)

At the start of the loop test, the display will show the result of the interactive player test:

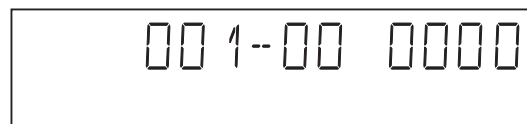

Figure 5-34

The left side of the display contains a 3-digit code, which can have a value between 000 and 111. These values are to be interpreted as follows:

Displayed Value	Indication for each module		
	Basic Engine	Mono PCB	Display PCB
000	ok	ok	ok
001	ok	ok	faulty
010	ok	faulty	ok
011	ok	faulty	faulty
100	faulty	ok	ok
101	faulty	ok	faulty
110	faulty	faulty	ok
111	faulty	faulty	faulty

Figure 5-35

The loop test will perform the same nuclei as the dealer test, but it will loop through the list of nuclei indefinitely. The display of the DVD player will display not only the three digits indicating correct/faulty modules and the last found error code (as mentioned, faults are detected as far as they can be within the scope of the diagnostic software), but also a loop counter indicating how many times the loop has been gone through. Example:

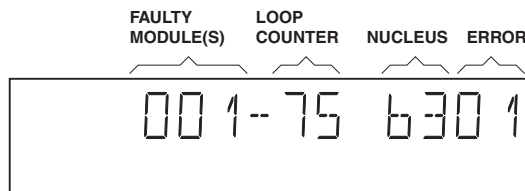

Figure 5-36

The number after the hyphen indicates the number of times the loop test has been performed; the 4 digits at the right side of the display show the last error that was found when running the loop test: the leftmost two digits of this code indicate which nucleus resulted in a fault; the rightmost two digits refer to the faultcode within that nucleus. For further explanation of this error code, see list of error codes below.

ERROR CODES LOOP TEST

ERROR CODE	NUCLEUS NUMBER	ERROR DESCRIPTION
0601	6	Calculated checksum of FLASH is not correct
1101	11	I2C bus busy before start
1102		NVRAM access time-out
1103		No NVRAM Acknowledge
1104		NVRAM reply time-out
1201	12	I2C bus busy
1202		I2C bus not working
1203		Slave controller not responding
1204		Slave response is not correct
1301	13	Parity error from basic engine to serial
1302		Parity error from serial to basic engine
1303		No communication between serial and basic engine
1304		Communication time-out error
1601	16	The SDRAM is faulty
5201	52	I2C bus busy
5202		Error sending I2C command to COLOR SETUP IC
5203		Colour setup IC not responding
5204		Colour setup IC response is not correct
5401	54	I2C bus busy
5402		Error sending I2C command to SCART SWITCH IC
5403		SCART Switch is not responding
5403		SCART Switch response is not correct

CL06532096_006.eps
050700

Figure 5-37

Error log / bits table	Read ERROR LOG in player script	Read ERROR BITS in player script
Basic engine errors	Value:	Value:
Command to the Basic Engine not allowed in this state or unknown command	150101	8
Parameter(s) from the command to the Basic Engine is not valid	150102	7
Sledge could not be moved to the inner home position	150103	6
Focus failure	150104	5
Turntable motor speed could not be reached within timeout	150105	4
Radial servo could not get on track on the disc	150106	3
PLL could not lock in the accessing or tracking state	150107	2
Subcode or sector information could not be read	150108	1
requested subcode could not be found	150109	16
Tray could not be closed or opened completely	15010A	15
TOC could not be read within timeout	15010B	14
The requested seek on the disc could not be executed	15010C	13
A requested lead-in is not on the disc	15010D	12
A non existing burst cutting area is requested	15010E	11
S2b communication error	1501F0	10
S2b communication error	1501F1	9
S2b communication error	1501F3	24
S2b communication error	1501F4	23
S2b communication error	1501F5	22
Digital PWB errors		
Communication error with the Sti 5505	90000	32
Communication error with the Sti 5505	90001	31
Display processor errors		
Communication error with the display processor	190000	40

5.6.1 Servicing DVD loader

The DVD Loader / mechanism, VAL6011, has to be exchanged completely in case of failure. A new mechanism can be ordered with codenumber 9305 023 61101.

5.6.2 Reprogramming of new mono boards.

Caution

This information is confidential and may not be distributed. Only a qualified service person should reprogram the mono board.

After reset of NV-memory or repair of the mono board, all the customer settings and also the region code will be lost.

Reprogramming of the mono board will put the player back in the state in which it has left the factory, i.e. with the default settings and the allowed region code.

Reprogramming is limited to 25 times

When the counter reaches 25, reprogramming is not possible anymore

Reprogramming will be done by way of the remote control.

Put the player in stop mode, no disc loaded.

Press the following keys on the remote control:

<PLAY> followed by numerical keys <1> <5> <9>

The display shows: "-----"

Press now successively the following keys :

for DVD612 /002 /021 /051 : <0><2><7> <0><0><0><0><0><0><0><0><0>

Press <PLAY> again.

The TV screen will become BLUE during a short time to confirm that the mono board has been reprogrammed, then the set goes to standby mode.

CL 16532007_008.eps
010201

Figure 5-38

5.6.3 Reset of Virgin Mode

After the player has been powered up for test by the dealer, it would have gone through the Virgin Mode. It is possible to reset the settings made during that mode before the delivery of player to the customer. This can be done as shown in the following diagram:

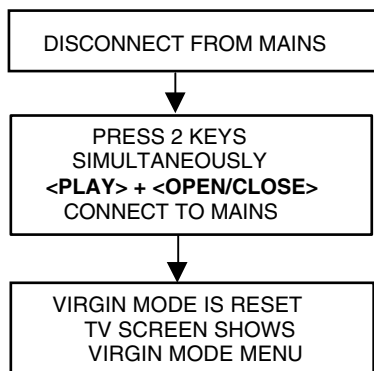

CL 96532065_034.eps
070700

Figure 5-39

TRADE MODE

When the player is in Trade Mode, the player cannot be controlled by means of the front key buttons, but only by means of the remote control.

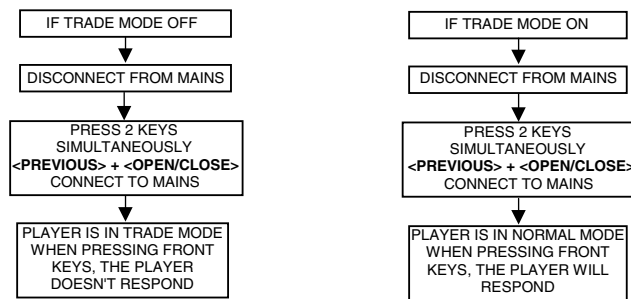

C06532096_008.eps
050700

Figure 5-40

5.7 Test Instruction Audio/Video Board

These test instructions can be used for all versions of the A/V board which has the following outputs:

- Audio L/R
- 5.1 Audio output
- Subwoofer output
- Optical / Coaxial digital output
- CVBS
- Y/G_vid,U/B_vid,V/R_vid output
- S-video
- Scart output

5.7.1 General

- All the waveforms measurement carried out in these test instruction will be base on the testpoint indicated in the A/V board schematic diagram in the Service manual.
- Impedance of the measuring-equipment should be > 1M Ω
- Most of the tests can be done using either the Diagnostic software " Player script" which can be found in the chapter "Diagnostic Software description and troubleshooting" or the Menu interface using the Service PC with a terminal emulation program (e.g. Window Hyperterminal) where it is possible to control the execution of the Diagnostic Nuclei
- Setup for the measurement will be done in set level with all modules connected as shown in the Wiring Block diagram.

5.7.2 General start-up measurement

Supply check:

Before starting the measurement,ensure that all power supply are connected to the A/V board.

Pin nbr	Supply
1010-9	-5V (-Vcc)
1010-10	+5V
1010-11	+5V

The supply currents can be measured using a Tektronics AM503B current probe or equivalent.

Supply	Power consumption (AVG)
+5VA	+5V \pm 3% I = 200mA
+5Vvid	+5V \pm 3% I = 200mA
-5V	-5V \pm 3% I = 200mA

Clock Check

Ensure the present of the clock to the DAC

Clock Name	Testpoint	Frequency
PCM_CLK	TP10	11.2896MHz \pm 0.02% tolerance

Audio mute check

Measure the Audio mute voltage input at pin 12 of connector 1010

Status	Value
AudioMuteOn	4.7V \pm 10%
AudioMuteOff	-8V \pm 10%

To toggle between ON and OFF,use the following commands:

Ref.#	Command Name	Remarks
19a	AudioMuteOn	Audio Mute On
19b	AudioMuteOff	Audio Mute Off

5.7.3 Audio DAC and amplifier

Ensure that the Audio mute signal is OFF

To check the DAC and buffer amplifier,send the following commands:

Ref.#	Command Name	Remarks	Audio output
21a	AudioSineOn	Audio Sine signal ON	Sine,1Khz on stereo
----	Press stop button	Audio Sine signal OFF	No waveform
20a	AudioPinkNoiseOn	Audio Pinknoise ON	Pink Noise on 6 channels
20b	AudioPinkNoiseOff	Audio Pinknoise OFF	No waveform

The audio signal (sine or pink noise) will also be present on the digital output (SPDIF).This can be checked by connecting digital signal to an amplifier with digital input. Check the I2S and audio signal at the following testpoints:

Name	Testpoint
LRCLK	TP8
SCLK	TP9
PCM_CLK	P10
PCM_OUT0	TP7
PCM_OUT1	TP27
PCM_OUT2	TP28
SPDIF	TP11
Front L/R out-Audio cinch	TP13
H/P L/R out	TP20
Analog out -Audio cinch	TP25

All waveforms can be refer to the waveform diagram in the chapter "Diagnostic software description and troubleshooting".

5.7.4 Video output and buffer amplifier

Check DC output-level at all video cinch output : 1.0V DC \pm 10%

Generate a color bar using the following software commands:

Ref.#	Command Name	Remarks
23a	VideoColDencOn	Colour DENC ON
61a	VideoColOutRGB	RGB Colourbar
61b	VideoColOutYUV	YUV Colourbar
23b	VideoColDencOff	Colourbar DENC OFF

Check the video outputs at the following testpoints:

Name	Testpoint
B_VID	TP1
G_VID	TP2
R_VID	TP3
CVBS out	TP14
S-Video-C out	TP15
S-Video-Y out	TP16
Y out	TP17
U out	TP18
V out	TP19

All waveforms can be refer to the waveform diagram in the chapter "Diagnostic Software description and troubleshooting".

5.7.5 Play and 16/9 detection

Check DC voltage at S-Video-chroma output (pin 4) with a 6K8 ohm load and Scart connector (pin 8) and change the 0/6/12 input (1010-8) using the following commands:

Ref.#	Command Name	Remarks	Chroma output
25a	VideoScartLo	Sends out 0V ± 0.5V	<0.1V
25b	VideoScartMi	Sends out 6V ± 10%	2.0V ± 10% with load 5.0V ± 10% without load
25c	VideoScartHi	Sends out 12V ± 10%	<0.1V

5.7.6 Kill circuit

To check the functionality of the Kill circuitry, the audio outputs has to be present by the following command:

Ref.#	Command Name	Remarks	Audio output
21a	AudioPinkNoiseOn	Audio Pinknoise ON	Pink Noise on 6 channels

Check the audio outputs at the audio cinch of the A/V board : Pink Noise

Activate the Kill circuit by using the following command:

Ref.#	Command Name	Remarks
19a	AudioMuteOn	Audio Mute On

Check the audio outputs at the audio cinch of the A/V board : No waveform

Switch off the kill circuit by using the following command:

Ref.#	Command Name	Remarks
19b	AudioMuteOff	Audio Mute Off

Check the audio outputs at the audio cinch of the A/V board : Pink Noise

5.8.2 Functionality description:

The essential component of the display PCB is the μ P (slave). This slave works on an 8MHz resonator and has a reset circuit that is triggered by the +5Vstby. After the reset pulse, the standby control line will release the reset of the host μ P. This host μ P will then initialise the slave. In addition, when going to stand-by, the slave will put the host μ P in reset. When the slave receives the right IR or key code to leave the standby mode, the reset of the host μ P will be released. Other slave functions are:

- Square signal generator to generate the filament voltage, which is required for an AC FTD.
- Generates the grid and segment scanning for the FTD.
- Generates a scanning grid for the keys (separated from display scanning).
- Has inputs for RC (RC5 and RC6) and P50 (P50 controller is built in).

5.8.3 General

- Oscilloscope measurements have been carried out using a Philips PM3392A.
- Impedance of measuring-equipment should be > 1M Ω .
- To do correct measurements we recommend to use supply 3122 427 22570.

5.8 Test instructions Display board

5.8.1 Introduction

These test instructions are written for all versions of the display PCBAS.

The contents of the PCB can be split up into next blocks:

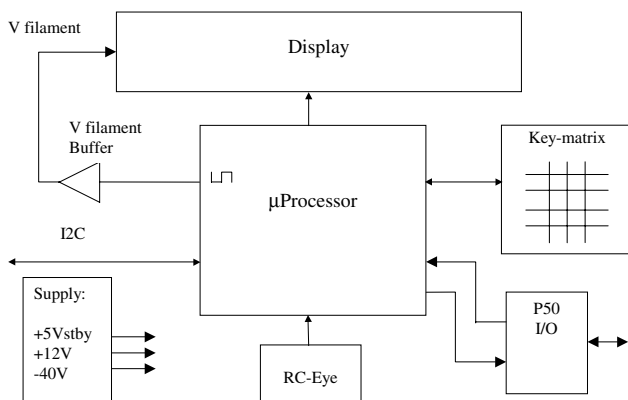

CL 96532065_008.eps
130799

Figure 5-41

5.8.4 Reset

Check next reset timing with an oscilloscope at pin 10 of the microprocessor.

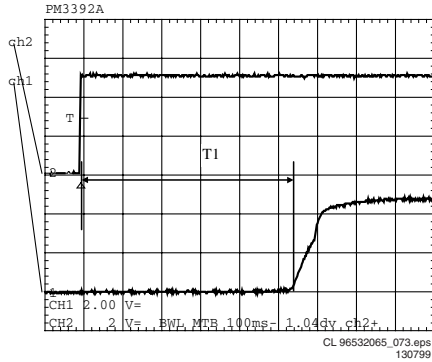

Figure 5-42

Timing: $400\text{msec} < T1 > 700\text{msec}$.
 CH1: +5Vstby voltage at power on.
 CH2: Voltage at pin 10.

5.8.5 Display steering

Check next timing and level for all grid-lines (G1 r G14).

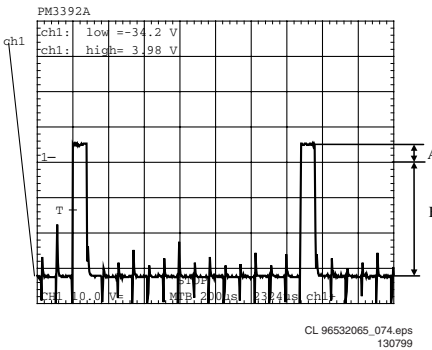

Figure 5-43

1. Check level A: +4V5 +/-10% for grid lines 1 => 11
2. Check level A: +4V0 +/-10% for grid lines 12 => 14
3. Check level B: -33V +/-10%
4. Check timing and levels of segment-lines P1 => P10:

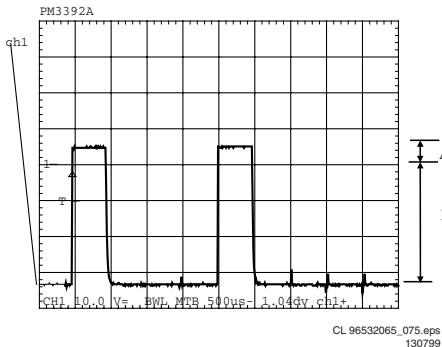

Figure 5-44

Level A: +4V5 +/-10%
 Level B: -33V +/-10%

The data on these segment lines depend on the characters that are displayed.

The characters can be set by sending I2C commands to the display.

See the Slave URS how to send a display command.

5.8.6 Key-matrix

Connect an extra 10kΩ pull-up to pin 36 en 37 of the μP and check next matrix scanning at these pins.

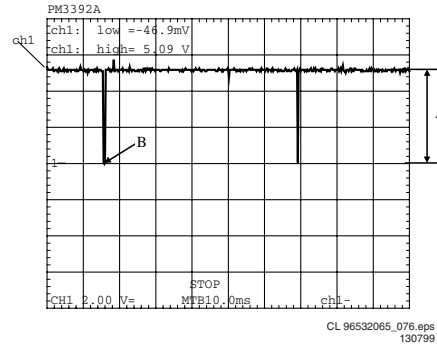

Figure 5-45

Level A: 5.0V +/-7%

Level B: 0V +/-200mV

Check matrix scanning from pin 26 until 33 of the μP. The results should be the same as the diagram above.

5.8.7 I.R. receiver

Check at pin 23 of the μP if this line switches from low (< 0.3V) to high (> 4.5V), while pressing a key on a Philips RC5 or RC6 remote control.

5.8.8 Karaoke interface

The karaoke interface (4 lines) is a single direction communication.

This means that it consists of four μP output lines.

The interface can be checked by setting or resetting these output-ports via the I2C bus.

Send next command via the I2C bus:

Address	: 0x70
Command byte	: 0x24
Data byte	: xxxabcd
Where	: a = Karaoke reset.
	: b = Karaoke data.
	: c = Karaoke clock.
	: d = Karaoke strobe.

5.8.9 P50 interface

P50 is a bi-directional serial interface, which is used for communication between video equipment. For European sets, this communication goes via pin 10 of the scart-bus. In other regions, it can be a cinch bus at the back of the set.

1. Keep the μP in reset by short-circuiting emitter and collector of transistor 7108, via resistor 3100 and 3104 transistor 7101 is switched on.
2. Check the voltage at the P50 output connector 1118-5: < 200mV.

When the reset is released the μP output-pin becomes low and transistor 7101 is switched off.

1. Check the voltage at the P50 output connector 1118-5: 4V9 +/-5%.
2. Check also the μP P50 input (μP pin 20): 5V +/-5%.
3. Connect the P50 line (connector 1118-5) to ground.
4. Check again the μP P50 input (μP pin 20): <0V3.

5.9 Troubleshooting

5.9.1 Troubleshooting A/V board

Testing of A/V board can be done using diagnostic software "PLAYER SCRIPT".

MONO board is used to generate a sound with the sound tests SND-1 and SND-2 or a VIDEO signal with the picture "DIAGNOSTIC SOFTWARE: SCRIPT INTERFACES".

AUDIO PART OF AUDIO/VIDEO BOARD 3139 243 30241

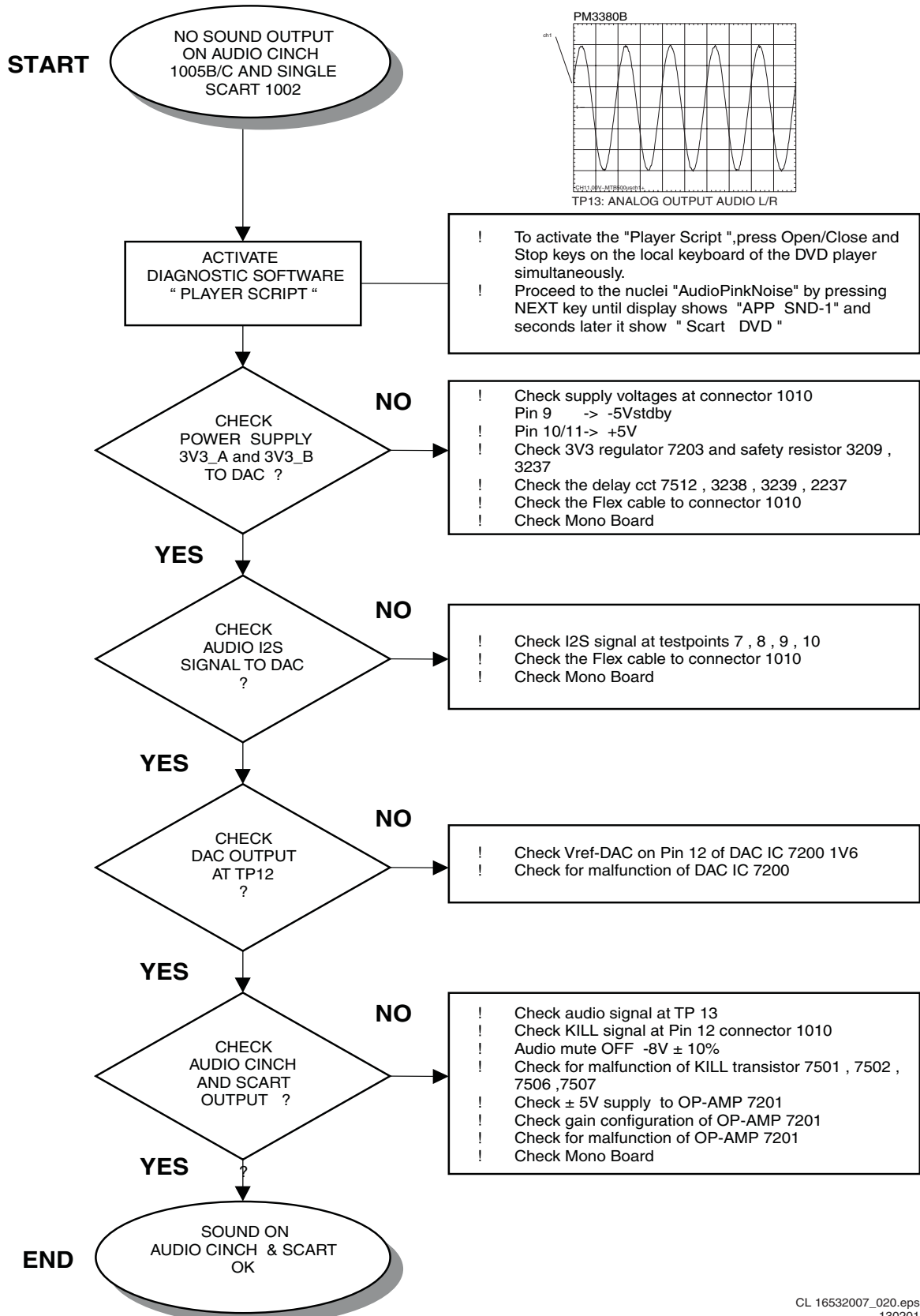

AUDIO WAVEFORM MEASUREMENT

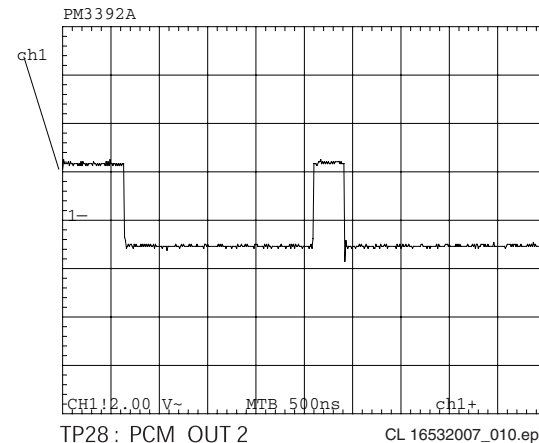
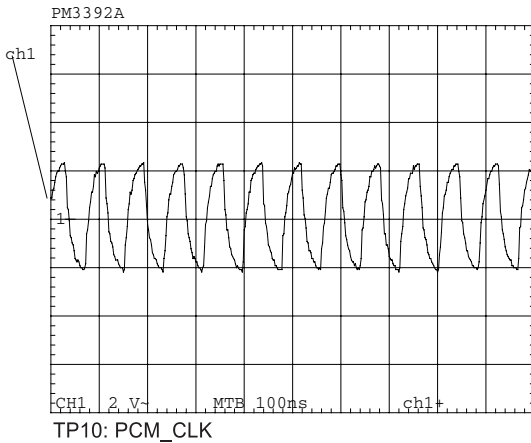
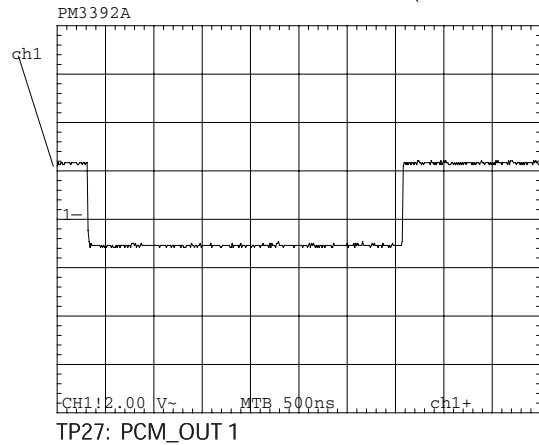
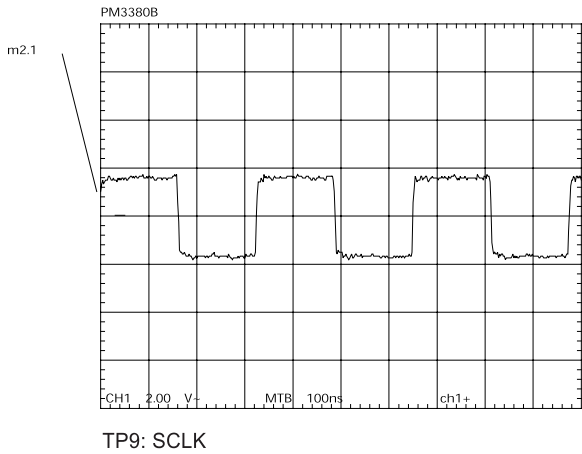
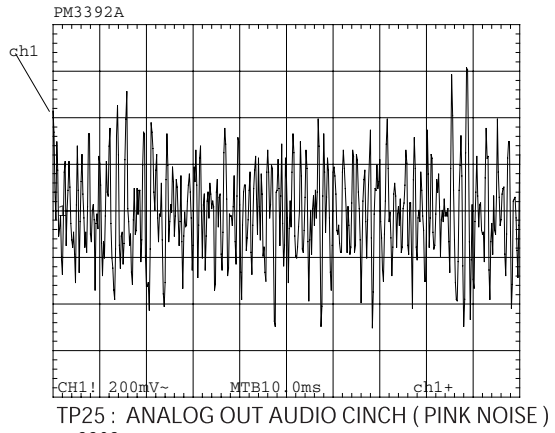
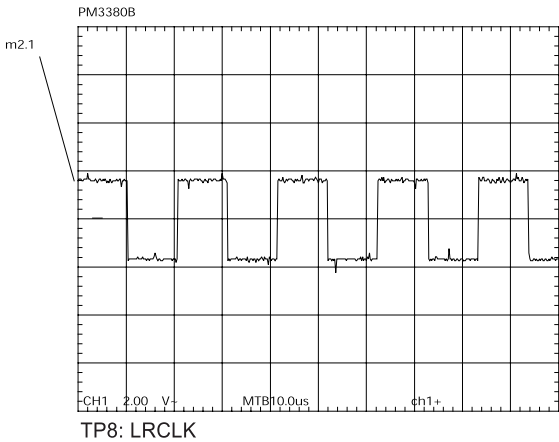
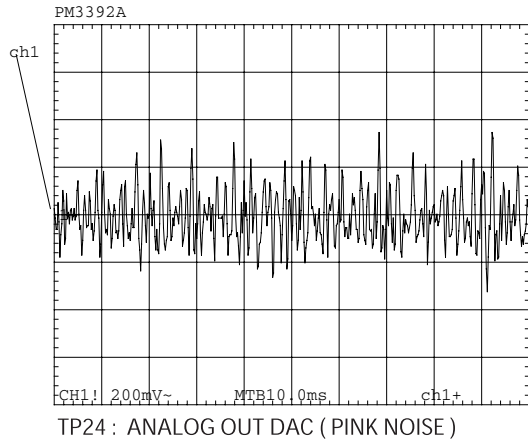
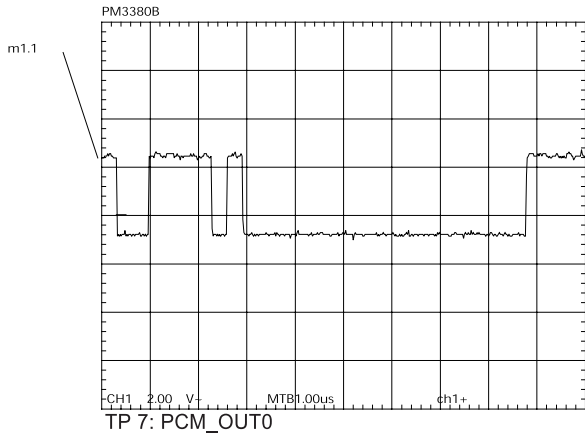

AUDIO PART OF AUDIO/VIDEO BOARD 3139 243 30241

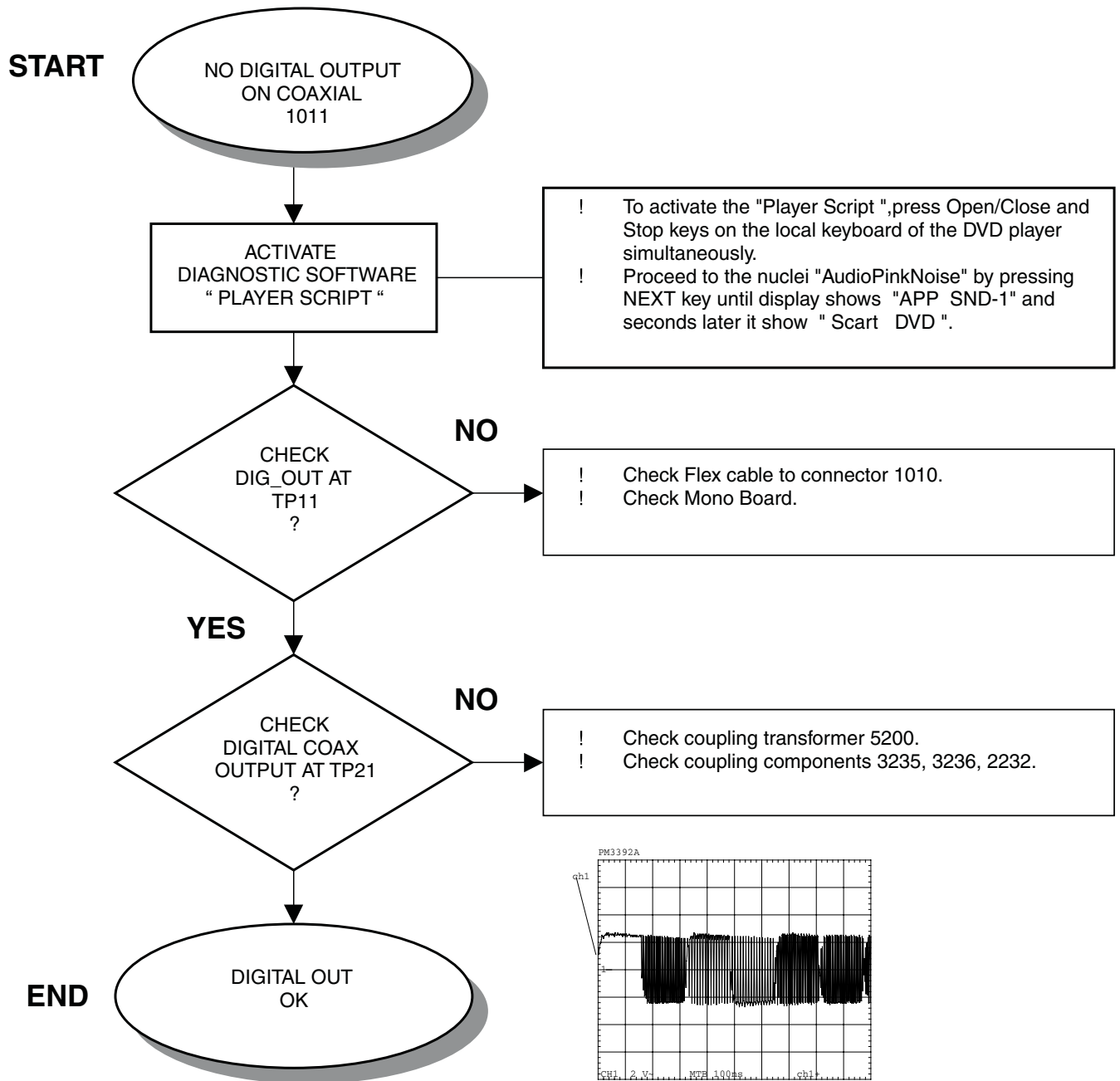

! To activate the "Player Script ",press Open/Close and Stop keys on the local keyboard of the DVD player simultaneously.
 ! Proceed to the nuclei "AudioPinkNoise" by pressing NEXT key until display shows "APP SND-1" and seconds later it show " Scart DVD ".

! Check Flex cable to connector 1010.
 ! Check Mono Board.

! Check coupling transformer 5200.
 ! Check coupling components 3235, 3236, 2232.

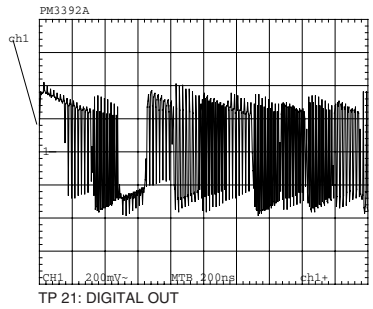
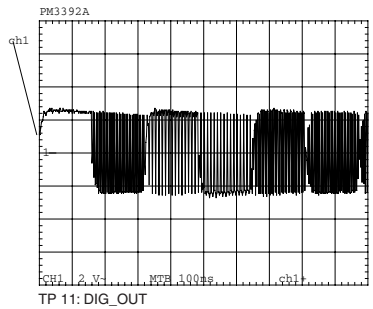

VIDEO PART OF AUDIO/VIDEO BOARD 3139 243 30241

START

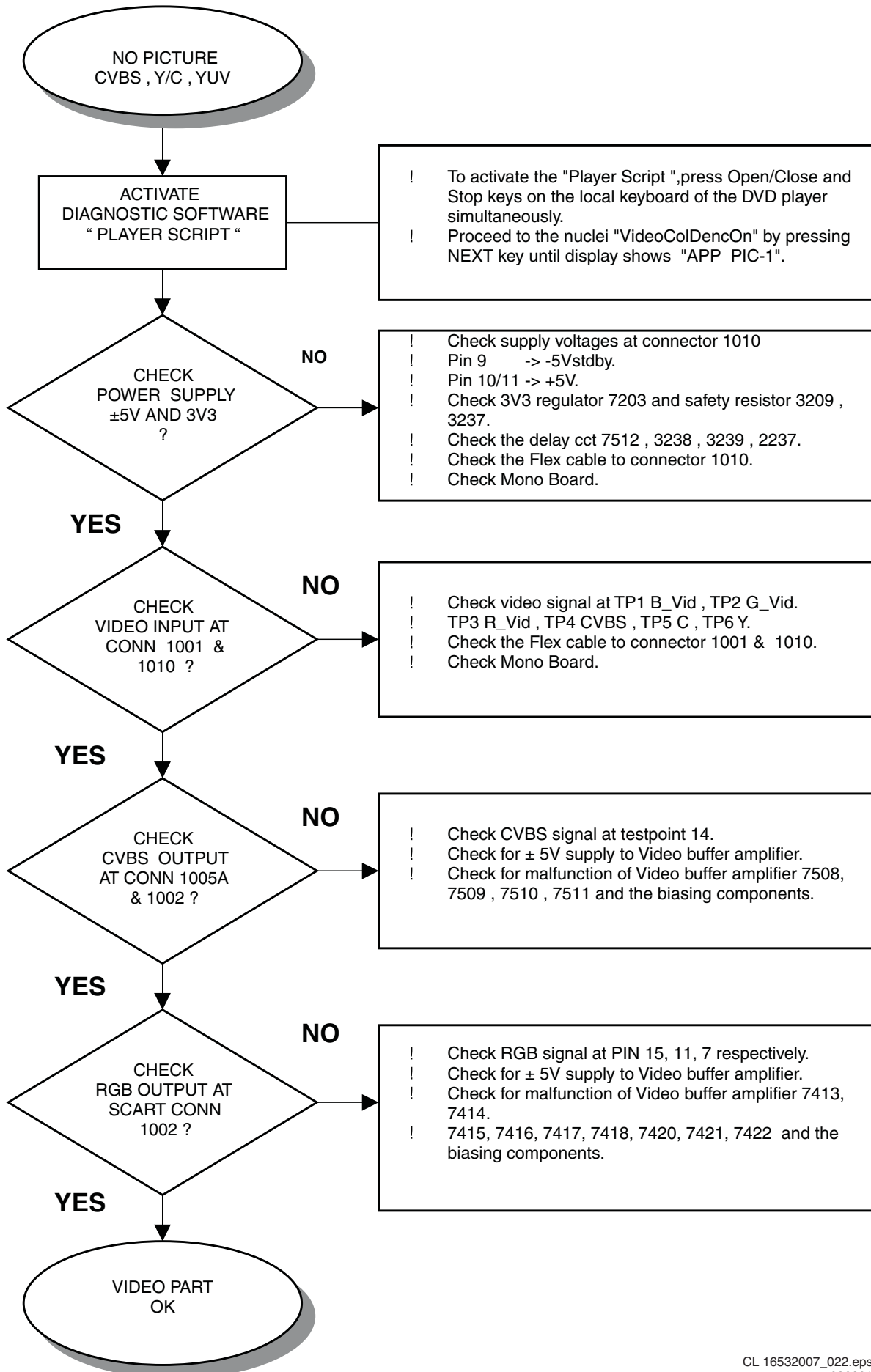

VIDEO WAVEFORM MEASUREMENT

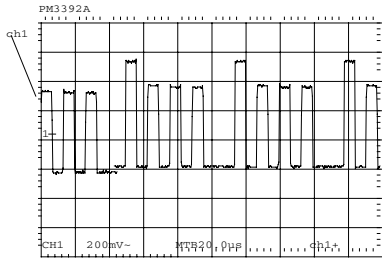

TP 1: VIDEO B

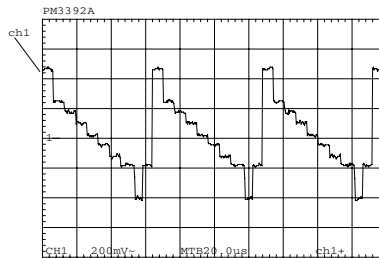

TP 6: Y_ENC

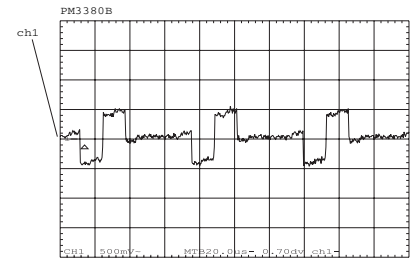

TP 19: V_VID OUT

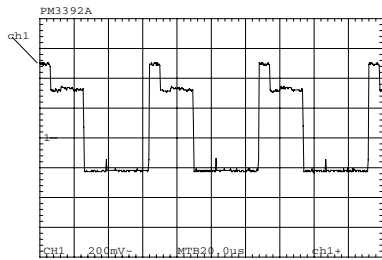

TP 2: VIDEO G

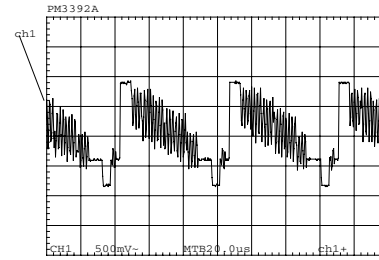

TP 14: CVBS_OUT

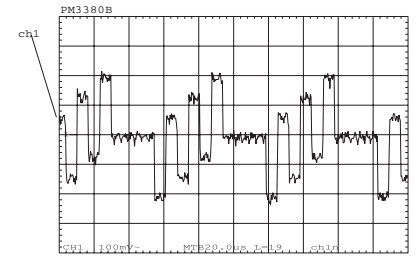

TP 22: U_VID

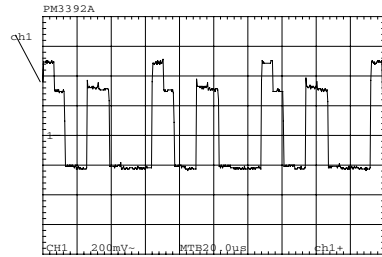

TP 3: VIDEO R

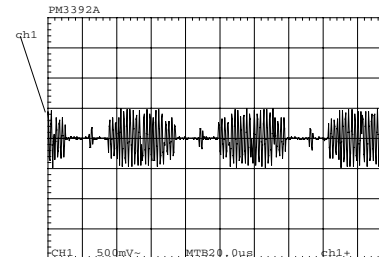

TP 15: C_OUT

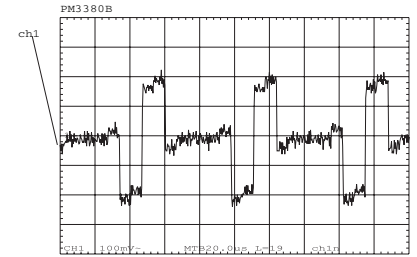

TP 23: V_VID

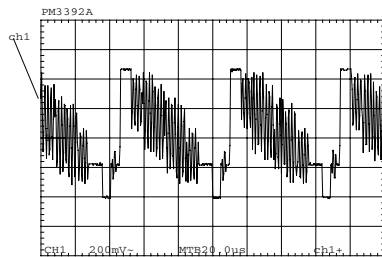

TP 4: CVBS

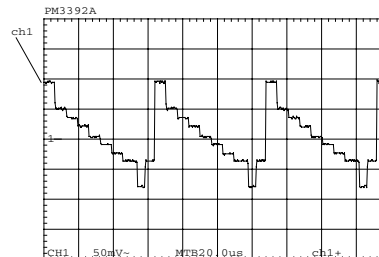

TP 16/17: Y_OUT

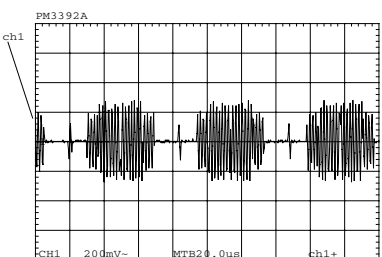

TP 5: C_ENC

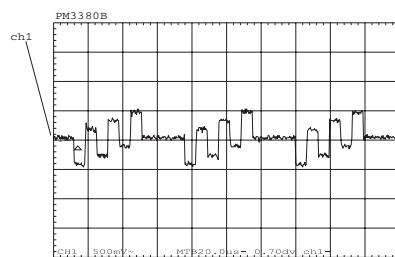

TP 18: U_VID OUT

TROUBLESHOOTING POWER SUPPLY UNIT VFM EURO

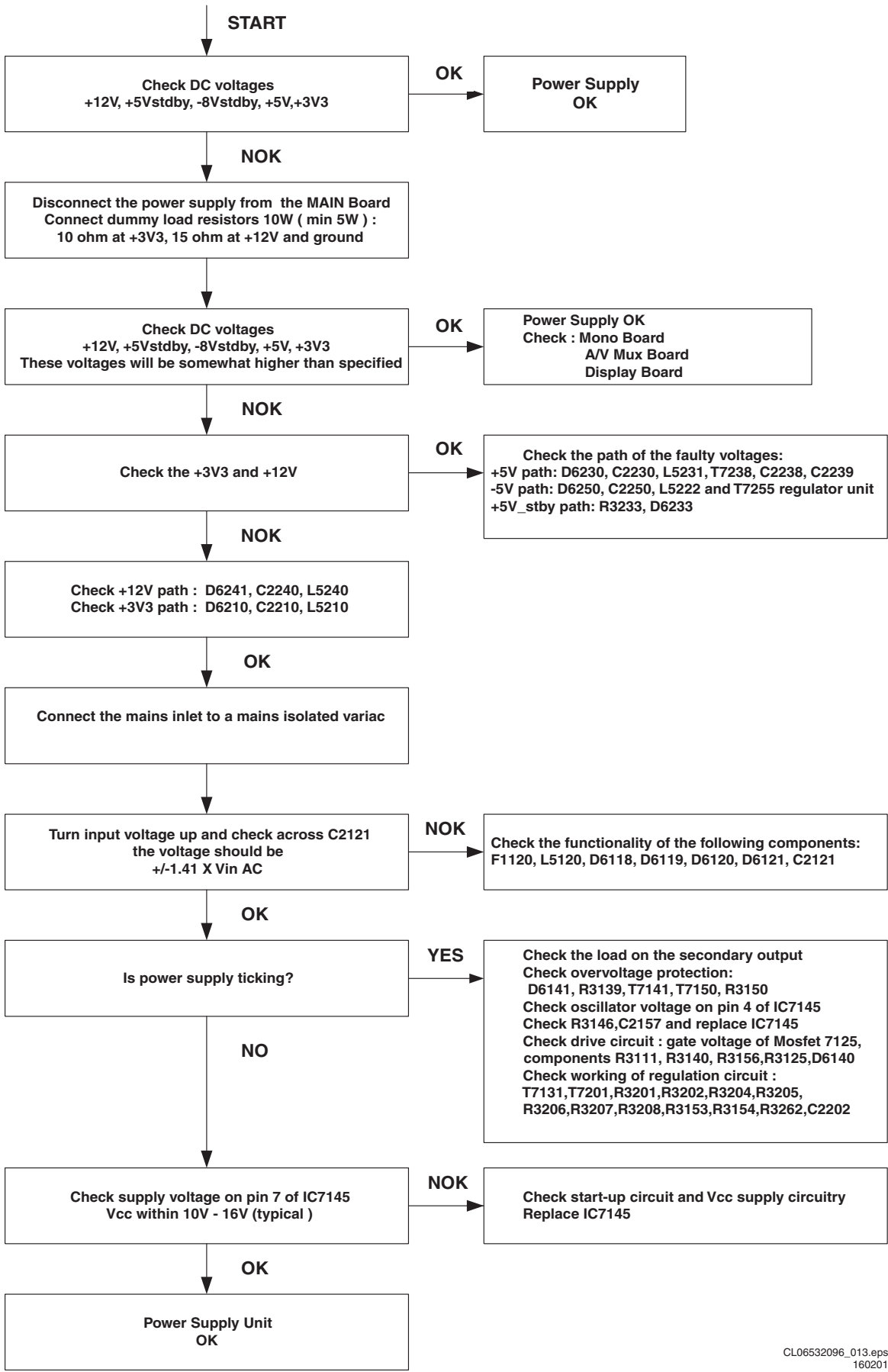

6. Block- and wiringdiagram.

Blockdiagram DVD 612 /XX1

Block Diagram DVD612/XX1

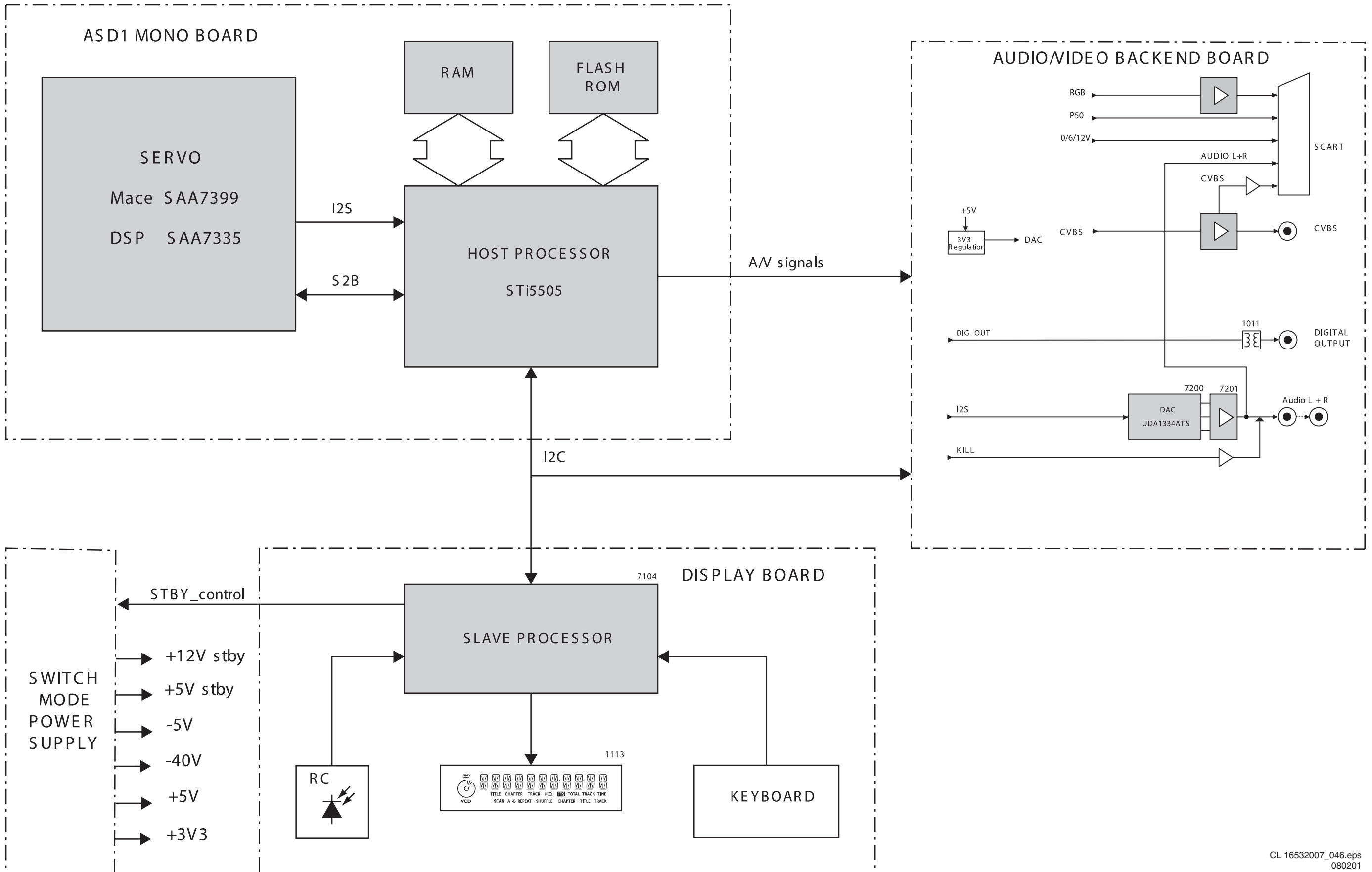

Wiringdiagram

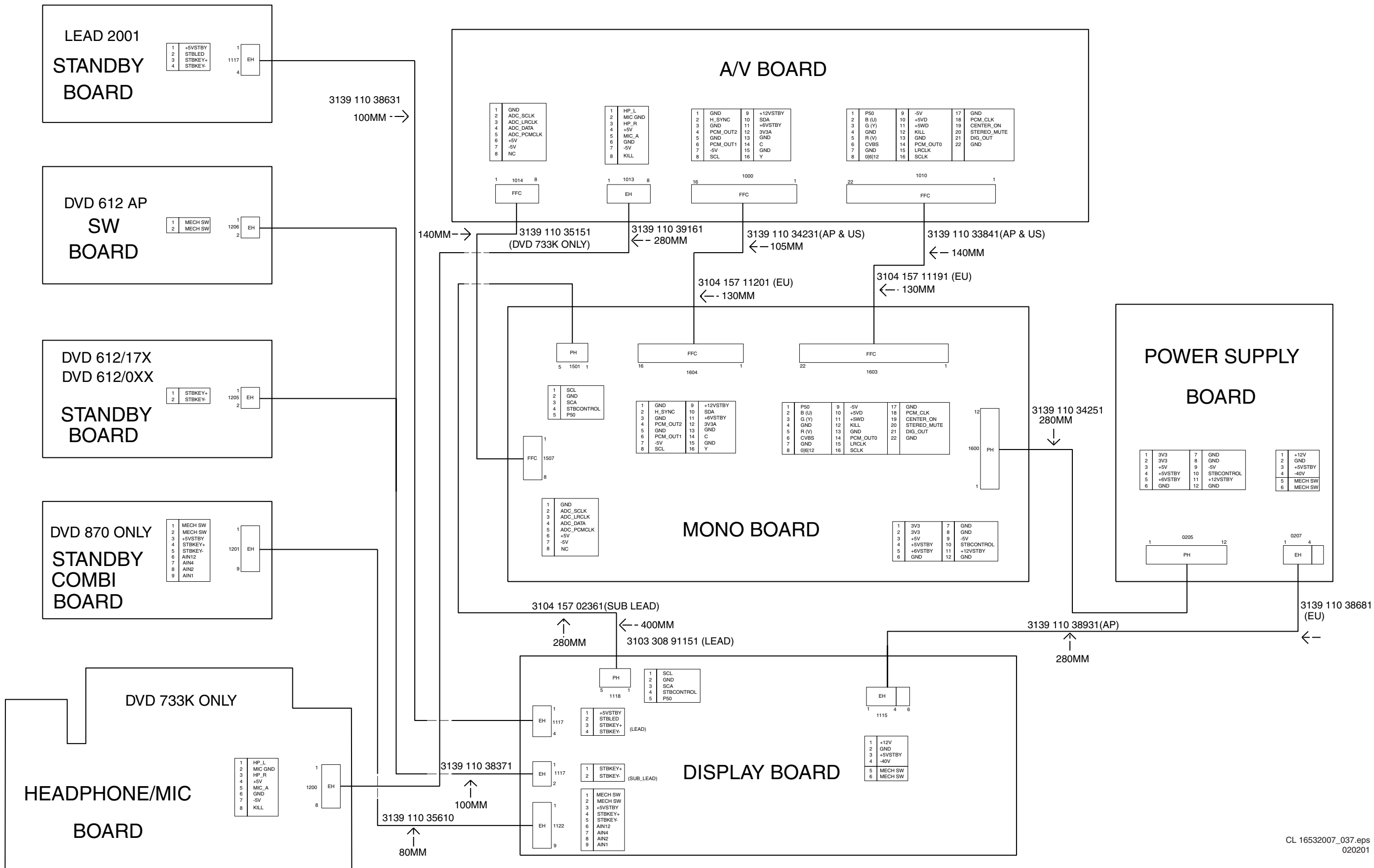

7. Electrical diagrams and Print-layouts

Power Supply Unit VFM EURO (3122 427 22570)

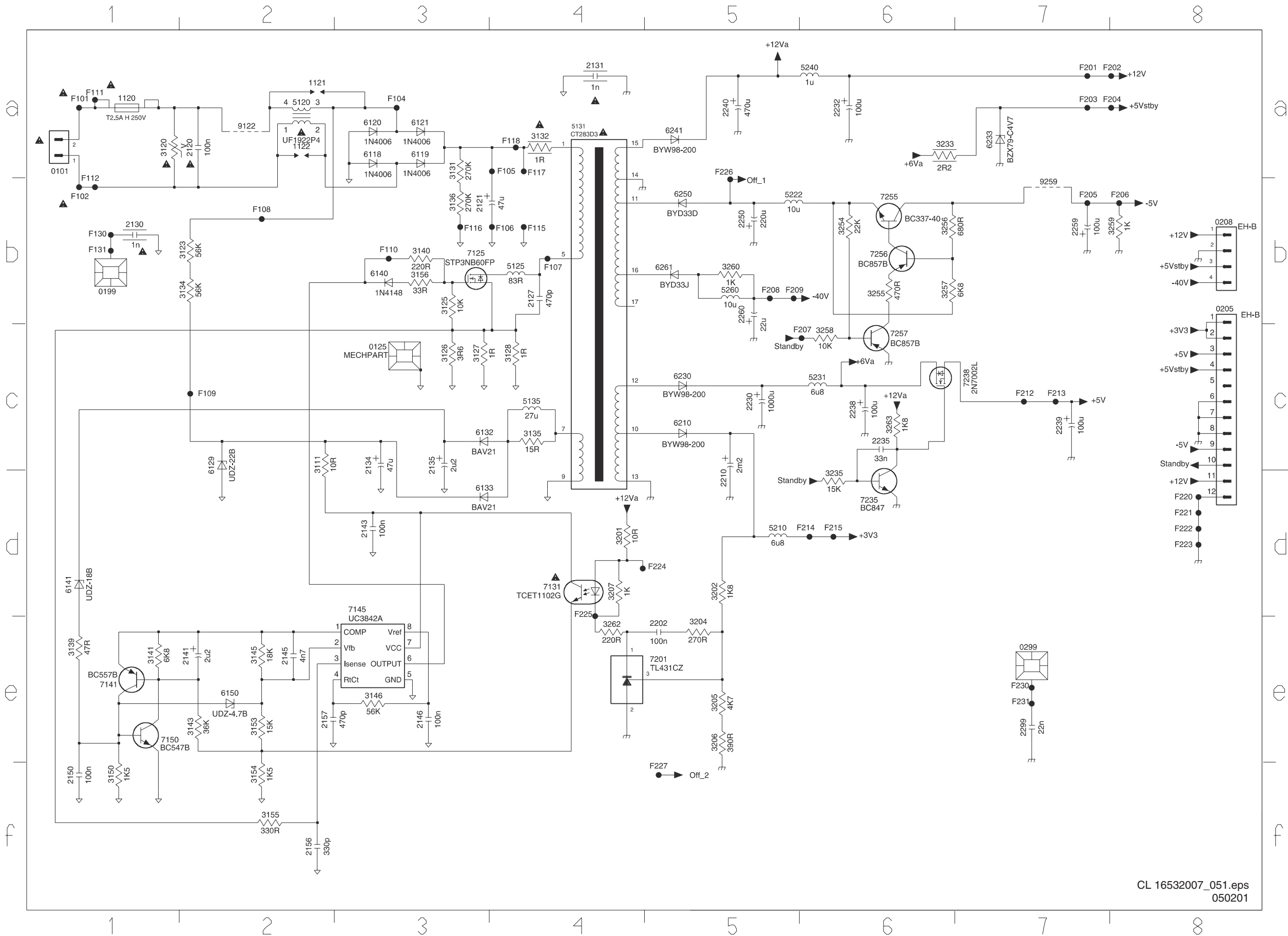

Layout Power Supply Unit VFM EURO (component side)

0101 B1 0209 A9 2121 B3 2130 A4 2135 C5 2232 A8 2240 A7 2259 C8 3111 C4 3123 B2 3133 A3 3201 C6 5120 A2 5210 C7 5260 A7 6120 B3 6128 A4 6211 C6 6241 A7 7125 B4 7201 C6 7259 C8 9203 B8 9259 C7
 0125 C4 0299 A8 2122 C2 2131 C5 2141 C3 2233 A8 2241 A6 2260 A7 3112 C5 3126 B4 3134 C3 3232 B8 5121 B2 5222 C6 6110 C3 6121 A3 6132 C5 6230 B6 6250 B6 7131 C6 7233 A8 9122 C2 9204 C9
 0199 A4 1120 C1 2123 B3 2132 C5 2210 C7 2236 B6 2250 C6 2261 A7 3120 C1 3127 B4 3135 C5 3233 C8 5125 B4 5230 B7 6111 C3 6122 C3 6133 C5 6231 B6 6259 C7 7141 C3 7236 B7 9125 B4 9205 B9
 0205 C9 2119 B2 2127 B4 2133 C5 2211 B7 2238 B7 2251 B6 2263 A6 3121 C3 3128 B4 3140 B4 3262 C6 5131 B6 5231 B7 6118 A3 6123 B3 6140 C4 6233 C9 6260 A6 7145 C4 7237 B8 9201 C6 9206 B9
 0208 A9 2120 C2 2129 C4 2134 C5 2230 B7 2239 B8 2253 C7 3105 C1 3122 B2 3132 B4 3155 C4 3263 B8 5135 B5 5240 A7 6119 A2 6127 A4 6210 B7 6240 B6 6261 A6 7150 C3 7255 C7 9202 C8 9207 B9

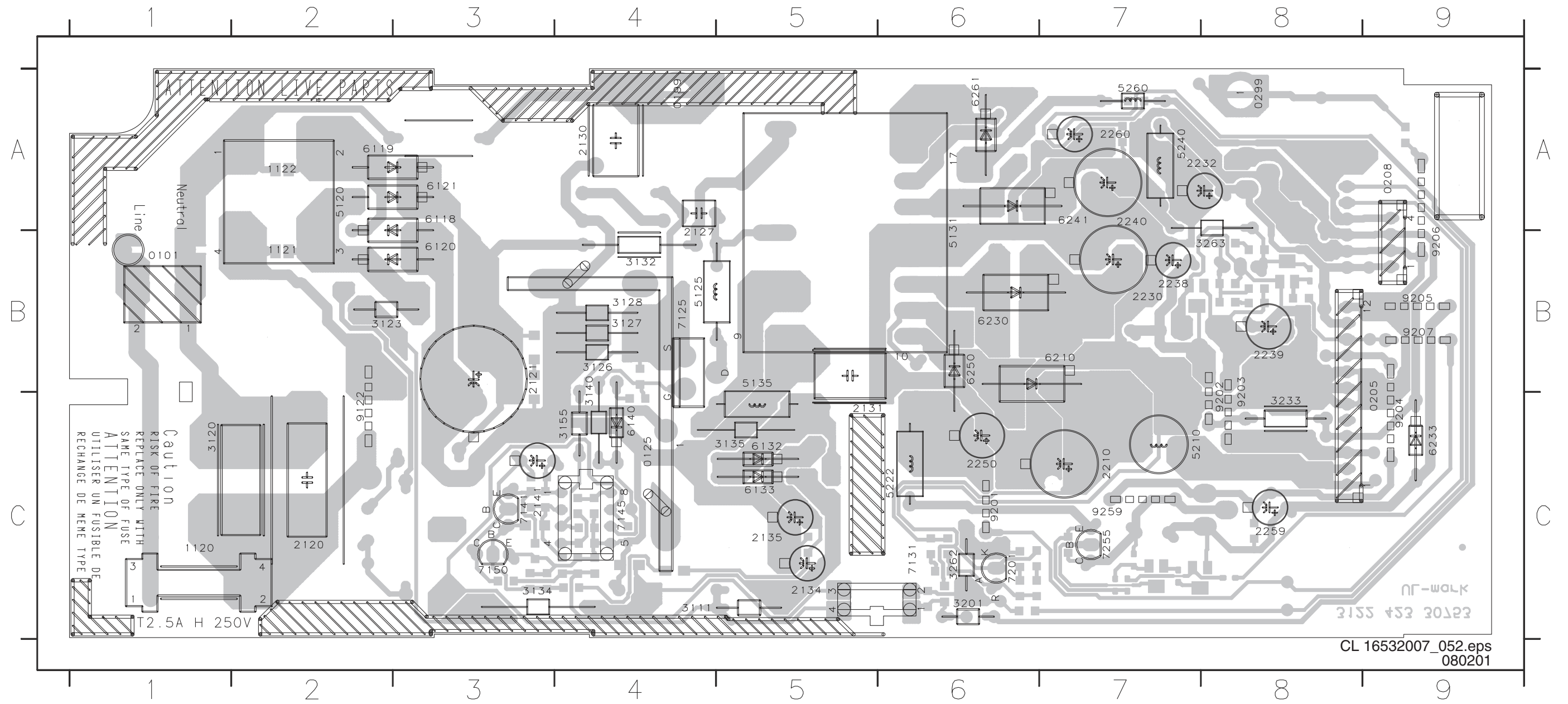

CL 16532007_052.eps
 080201

Layout Power Supply Unit VFM EURO (bottom side)

2142 A3 2146 A4 2156 A4 2202 A6 2235 B8 3125 B4 3137 A5 3143 A3 3150 A3 3156 A4 3204 A6 3207 A6 3235 B8 3241 B8 3255 A7 3258 A8 4201 B7 6141 A4 7238 B7
 2143 A4 2150 A3 2157 A4 2203 A6 2262 B8 3131 B3 3139 A4 3145 A3 3153 A4 3202 A6 3205 A6 3208 A6 3236 B8 3253 A7 3256 A7 3259 A8 4202 C7 6150 A3 7256 A7
 2145 A3 2152 A4 2201 A6 2234 B8 2299 C9 3136 B3 3141 A3 3146 A4 3154 A4 3203 A6 3206 A6 3234 B8 3237 B8 3254 A7 3257 A7 3260 C7 6129 A4 7235 B8 7257 A7

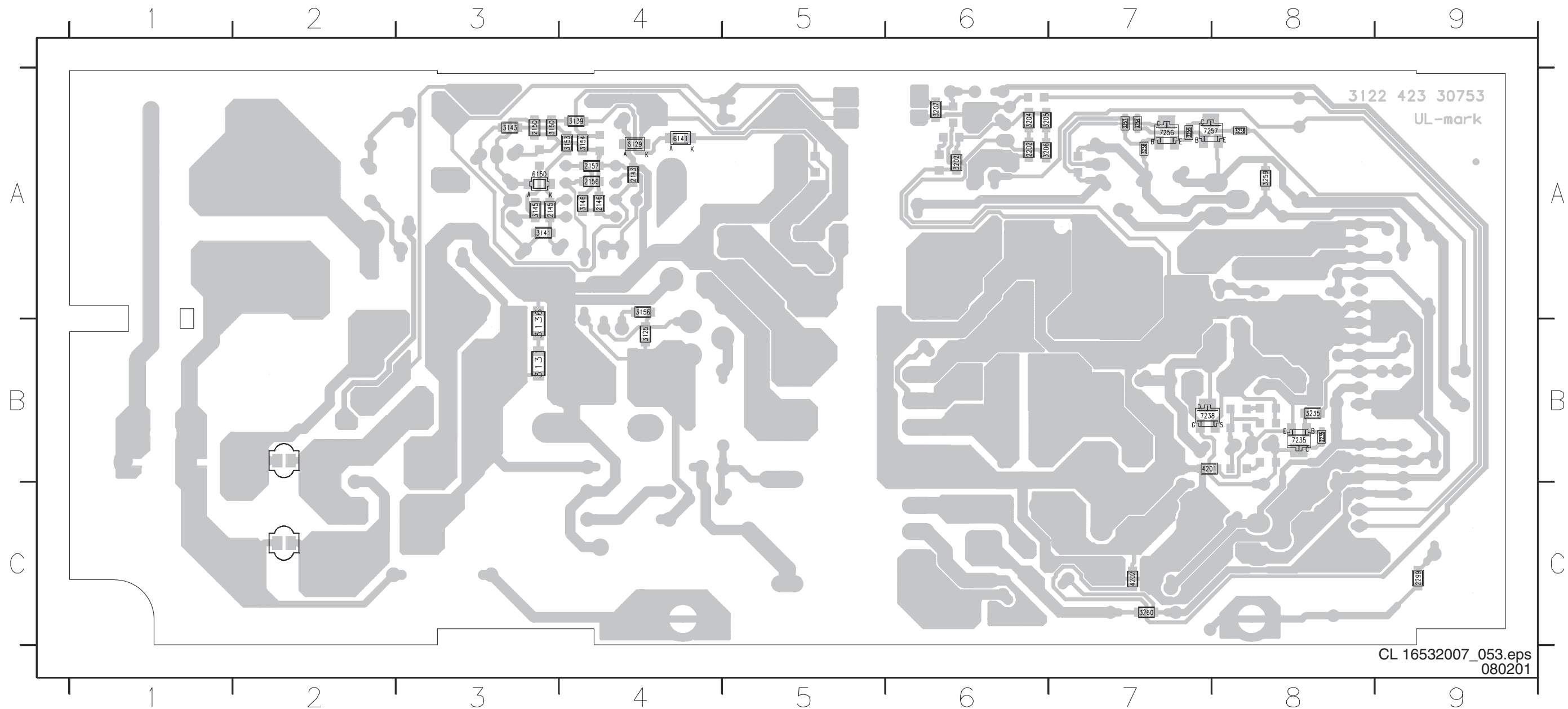

A/V Board (Video control & SCART)

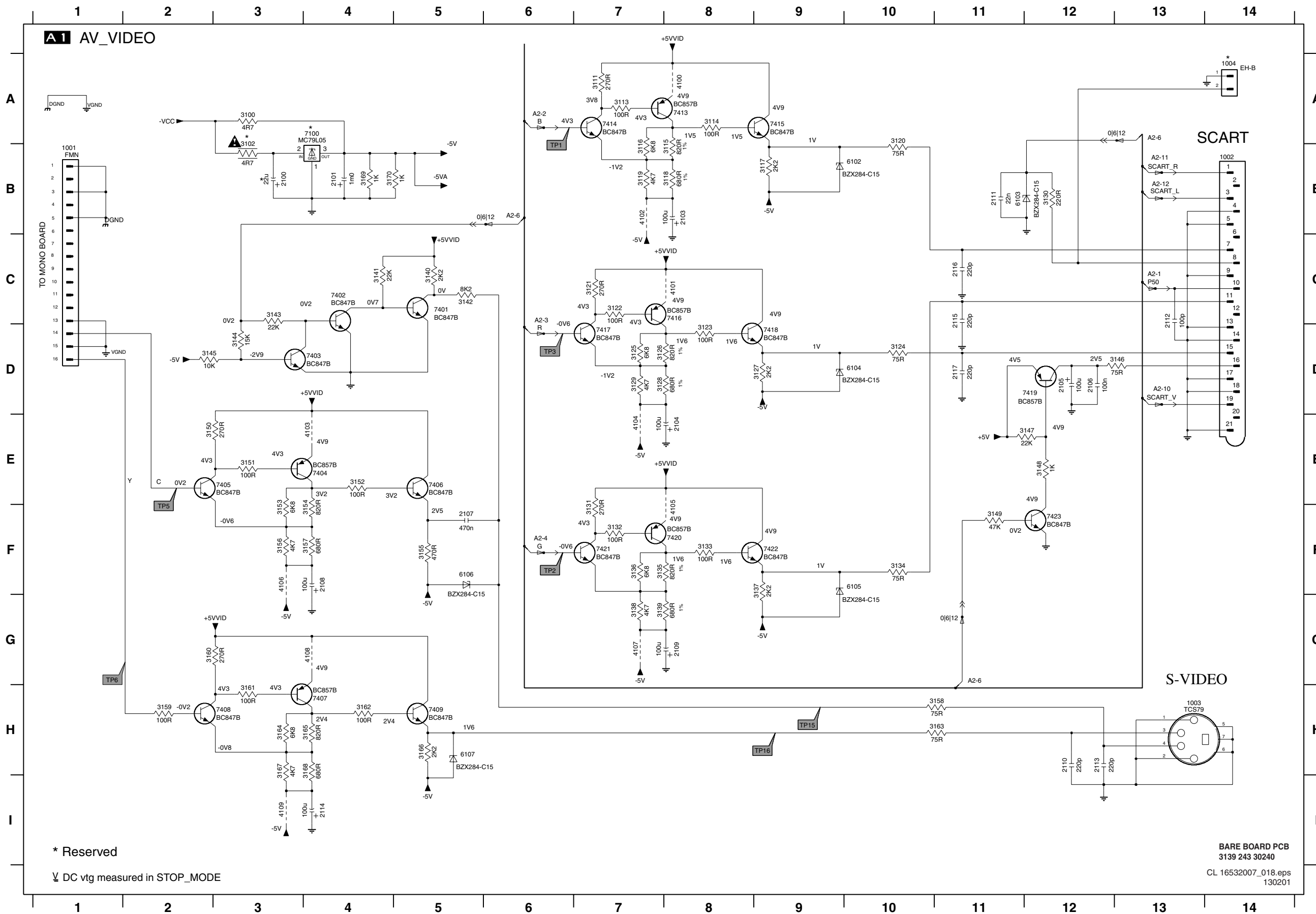

* Reserved

∇ DC vtg measured in STOP_MODE

BARE BOARD PCB
 3139 243 30240
 CL 16532007_018.eps
 130201

- 1001 B1
- 1002 B14
- 1003 H13
- 1004 A14
- 2100 B3
- 2101 B4
- 2103 B8
- 2104 E8
- 2105 D12
- 2106 D12
- 2107 F5
- 2108 F4
- 2109 G8
- 2110 H12
- 2111 B11
- 2112 C13
- 2113 H12
- 2114 I4
- 2115 C11
- 2116 C11
- 2117 D11
- 3100 A3
- 3102 B3
- 3111 A7
- 3113 A7
- 3114 A8
- 3115 B8
- 3116 B7
- 3117 B9
- 3118 B8
- 3119 B7
- 3120 A10
- 3121 C7
- 3122 C7
- 3123 D8
- 3124 D10
- 3125 D7
- 3126 D7
- 3127 D9
- 3128 D7
- 3129 D7
- 3130 B12
- 3131 F7
- 3132 F7
- 3133 F8
- 3134 F10
- 3135 F7
- 3136 F7
- 3137 F9
- 3138 G7
- 3139 G7
- 3140 C5
- 3141 C4
- 3142 C5
- 3143 C3
- 3144 D3
- 3145 D2
- 3146 D13
- 3147 E12
- 3148 E12
- 3149 F11
- 3150 E2
- 3151 E3
- 3152 E4
- 3153 F3
- 3154 F4
- 3155 F5
- 3156 F3
- 3157 F4
- 3158 H11
- 3159 H2
- 3160 G2
- 3161 H3
- 3162 H4
- 3163 H11
- 3164 H3
- 3165 H4
- 3166 H5
- 3167 H3
- 3168 H4
- 3169 B4
- 3170 B4
- 4100 A8
- 4101 C8
- 4102 B7
- 4103 E4
- 4104 E7
- 4105 F8
- 4106 F3
- 4107 G7
- 4108 G4
- 4109 I3
- 6102 B10
- 6103 B11
- 6104 D10
- 6105 F10
- 6106 F5
- 6107 H5
- 7100 A4
- 7401 C5
- 7402 C4
- 7403 D4
- 7404 E4
- 7405 E3
- 7406 E5
- 7407 H4
- 7408 H3
- 7409 H5
- 7413 A8
- 7414 A7
- 7415 A9
- 7416 C8
- 7417 D7
- 7418 D9
- 7419 D11
- 7420 F8
- 7421 F7
- 7422 F9
- 7423 F12

AV Board (Sound)

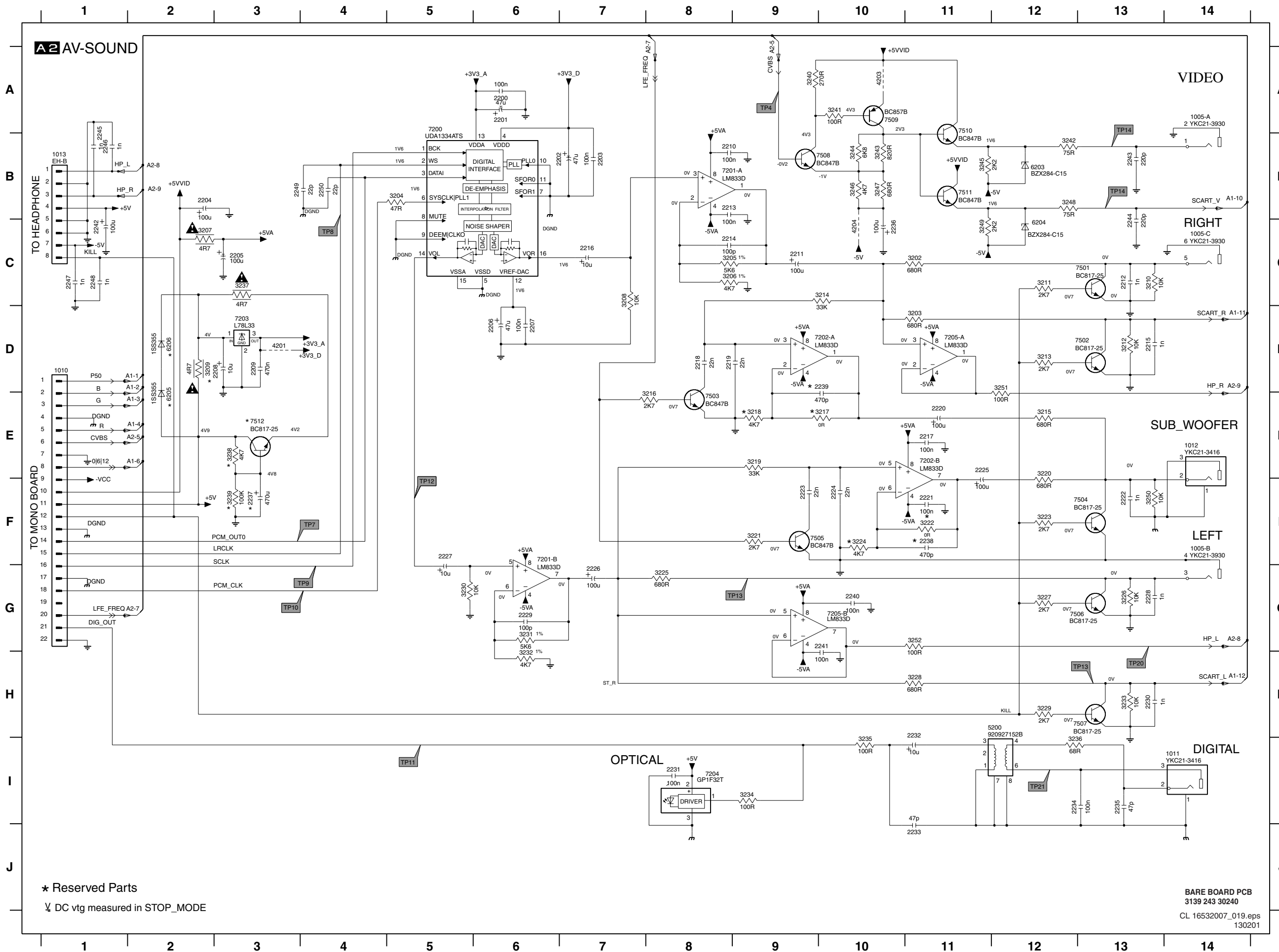

* Reserved Parts
 √ DC vtg measured in STOP_MODE

BARE BOARD PCB
 3139 243 30240
 CL 16532007_019.eps
 130201

- 1005-A A14
- 1005-B F14
- 1005-C C14
- 1010 D1
- 1011 H4
- 1012 E14
- 1013 B1
- 2200 A6
- 2201 A6
- 2202 B7
- 2203 B7
- 2204 B2
- 2205 C3
- 2206 D6
- 2207 D6
- 2208 D3
- 2209 D3
- 2210 B8
- 2211 C9
- 2212 C13
- 2213 B8
- 2214 C8
- 2215 D13
- 2216 C7
- 2217 E11
- 2218 D8
- 2219 D8
- 2220 E11
- 2221 F11
- 2222 F13
- 2223 F9
- 2224 F10
- 2225 E11
- 2226 G7
- 2227 F5
- 2228 G13
- 2229 B6
- 2230 H13
- 2231 I8
- 2232 H11
- 2233 J11
- 2234 H12
- 2235 H3
- 2236 C10
- 2237 F3
- 2238 F11
- 2239 D10
- 2240 G10
- 2241 G10
- 2242 C1
- 2243 B13
- 2244 C13
- 2245 B1
- 2246 B1
- 2247 C1
- 2248 C1
- 2249 B3
- 2250 B4
- 3202 C11
- 3203 D11
- 3204 B5
- 3205 C8
- 3206 C8
- 3207 C2
- 3208 C7
- 3209 D2
- 3210 C13
- 3211 C12
- 3212 D13
- 3213 D12
- 3214 C10
- 3215 E12
- 3216 E8
- 3217 E10
- 3218 E9
- 3219 E9
- 3220 E12
- 3221 F9
- 3222 F11
- 3223 F12
- 3224 F10
- 3225 G8
- 3226 G13
- 3227 G12
- 3228 H11
- 3229 H12
- 3230 G5
- 3231 G6
- 3232 H6
- 3233 H13
- 3234 I9
- 3235 I10
- 3236 I12
- 3237 C3
- 3238 E3
- 3239 F3
- 3240 A9
- 3241 A10
- 3242 B12
- 3243 B10
- 3244 B10
- 3245 B11
- 3246 B10
- 3247 B10
- 3248 B12
- 3249 C11
- 3250 F13
- 3251 D12
- 3252 G11
- 4201 D3
- 4203 A10
- 4204 C10
- 5200 H11
- 6203 B12
- 6204 C12
- 6205 E2
- 6206 D2
- 7200 A5
- 7201-A B8
- 7201-B F6
- 7205-A D9
- 7202-B E11
- 7203 D3
- 7204 I8
- 7205-A D11

Layout A/V Board (component side)

1001	A8	1010	B5	2101	A3	2109	B12	2205	B9	2220	C4	2236	D9	3145	A15	3221	D6	3235	C3	7204	D3	9304	C4	9310	A9	9316	B11	9321	A13	9327	C14	9332	B8
1002	D12	1011	D1	2103	B14	2114	C16	2206	B5	2225	C5	2237	B2	3149	A11	3223	C4	3251	B9	9300	A4	9305	B6	9311	A10	9317	A12	9322	A13	9328	C15	9333	C8
1003	C15	1012	D4	2104	B11	2201	A6	2208	B1	2226	B8	2242	B3	3159	A16	3228	B10	5200	C1	9301	B4	9306	C9	9312	A11	9318	A12	9323	B12	9329	C15	9334	A15
1004	B13	1013	B10	2105	C11	2202	B5	2211	C8	2227	A7	3143	A14	3203	C9	3229	D14	7100	A2	9302	B4	9307	B7	9313	C10	9319	A13	9324	C12	9330	A12	9335	A4
1005	D8	2100	A1	2108	A16	2204	A16	2216	B6	2232	C2	3144	A14	3204	B6	3234	C3	7203	B1	9303	B4	9308	A9	9314	C10	9320	A13	9325	B14	9331	B4	9336	A4

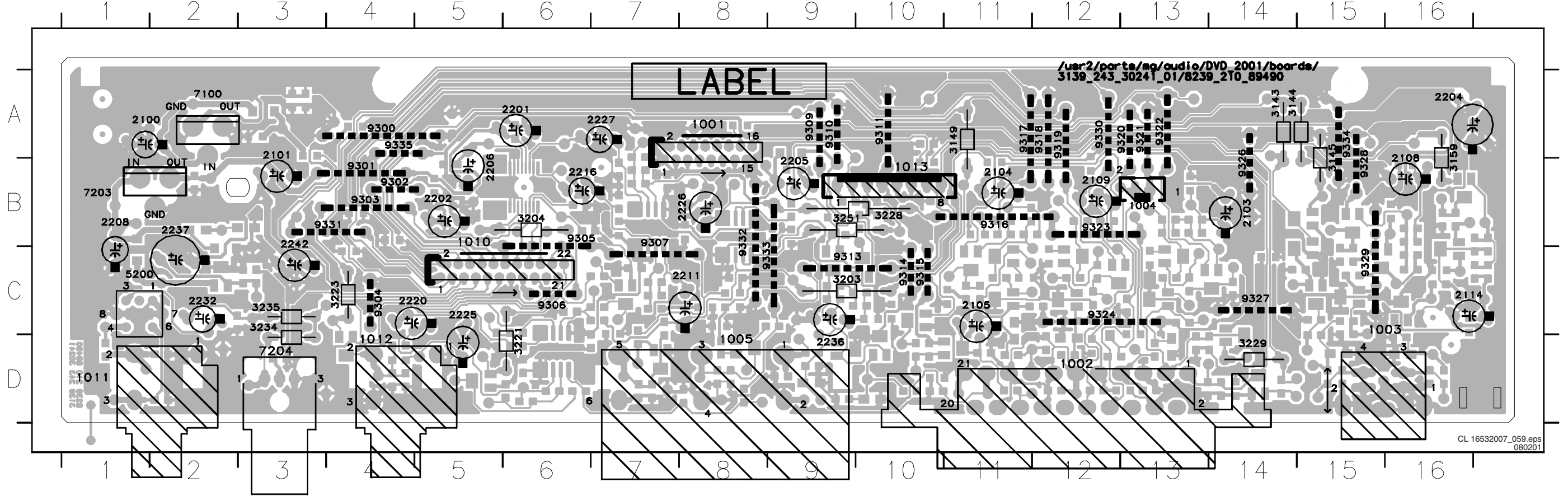

Display board

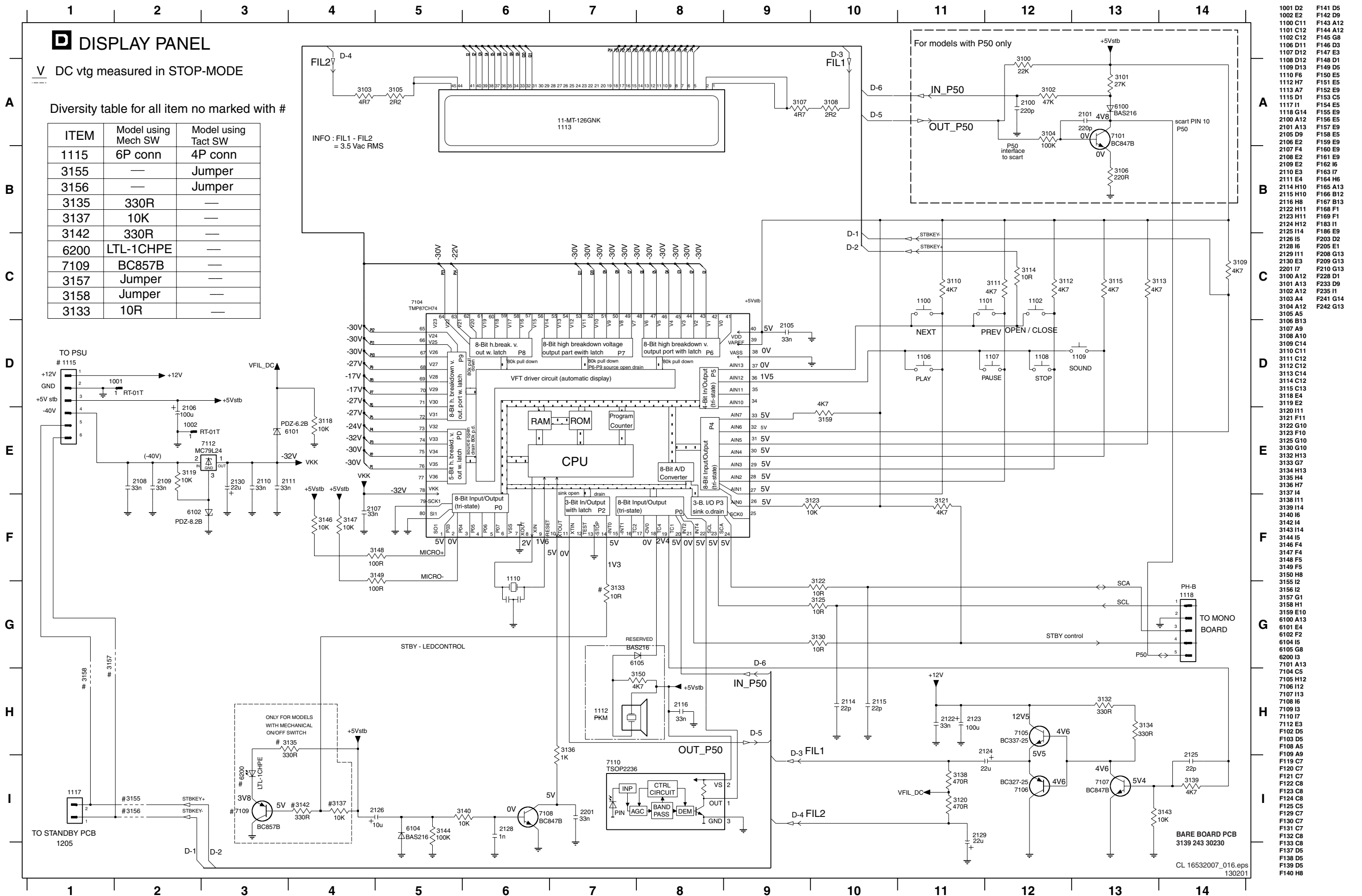

DISPLAY PANEL

V DC vtg measured in STOP-MODE

Diversity table for all item no marked with #

ITEM	Model using Mech SW	Model using Tact SW
1115	6P conn	4P conn
3155	—	Jumper
3156	—	Jumper
3135	330R	—
3137	10K	—
3142	330R	—
6200	LTL-1CHPE	—
7109	BC857B	—
3157	Jumper	—
3158	Jumper	—
3133	10R	—

- 1001 D2
- 1002 E2
- 1100 C11
- 1101 C12
- 1102 C12
- 1106 D11
- 1107 D12
- 1108 D12
- 1109 D13
- 1110 F6
- 1112 H7
- 1113 A7
- 1115 D1
- 1117 I1
- 1118 G14
- 2100 A12
- 2101 A13
- 2105 D9
- 2106 E2
- 2107 F4
- 2108 E2
- 2109 E2
- 2110 E3
- 2111 E4
- 2114 H10
- 2115 H10
- 2116 H8
- 2122 H11
- 2123 H11
- 2124 H12
- 2125 I14
- 2126 I5
- 2128 I6
- 2129 I11
- 2130 E3
- 2201 I7
- 3100 A12
- 3101 A13
- 3102 A12
- 3103 A4
- 3104 A12
- 3105 A5
- 3106 B13
- 3107 A9
- 3108 A10
- 3109 C14
- 3110 C11
- 3111 C12
- 3112 C12
- 3113 C14
- 3114 C12
- 3115 C13
- 3118 E4
- 3119 E2
- 3120 I11
- 3121 F11
- 3122 G10
- 3123 F10
- 3125 G10
- 3130 G10
- 3132 H13
- 3133 G7
- 3134 H13
- 3135 H4
- 3136 H7
- 3137 I4
- 3138 I11
- 3139 I14
- 3140 I6
- 3142 I4
- 3143 I14
- 3144 I5
- 3146 F4
- 3147 F4
- 3148 F5
- 3149 F5
- 3150 H8
- 3155 I2
- 3156 I2
- 3157 G1
- 3158 H1
- 3159 E10
- 6100 A13
- 6101 E4
- 6102 F2
- 6104 I5
- 6105 G8
- 6200 I3
- 7101 A13
- 7104 C5
- 7105 H12
- 7106 I12
- 7107 I13
- 7108 I6
- 7109 I3
- 7110 I7
- 7112 E3
- F102 D5
- F103 D5
- F108 A5
- F109 A9
- F119 C7
- F120 C7
- F121 C7
- F122 C8
- F123 C8
- F124 C8
- F125 C5
- F129 C7
- F130 C7
- F131 C7
- F132 C8
- F133 C8
- F137 D5
- F138 D5
- F139 D5
- F140 H8
- F141 D5
- F142 D9
- F143 A12
- F144 A12
- F145 G8
- F146 D3
- F147 E3
- F148 D1
- F149 D5
- F150 E5
- F151 E5
- F152 E9
- F153 C5
- F154 E5
- F155 E9
- F156 E5
- F157 E9
- F158 E5
- F159 E9
- F160 E9
- F161 E9
- F162 I6
- F163 I7
- F164 H6
- F165 A13
- F166 B12
- F167 B13
- F168 F1
- F169 F1
- F183 I1
- F186 E9
- F203 D2
- F205 E1
- F208 G13
- F209 G13
- F210 G13
- F228 D1
- F233 D9
- F235 I1
- F241 G14
- F242 G13

Layout Display Board (component side)

1001 A9 1100 A8 1102 A7 1107 A8 1108 A8 1109 A8 1113 A4 1115 A9 2108 A6 2123 A8 2129 A7 2200 A6 7106 A8 7112 A6 9212 A9

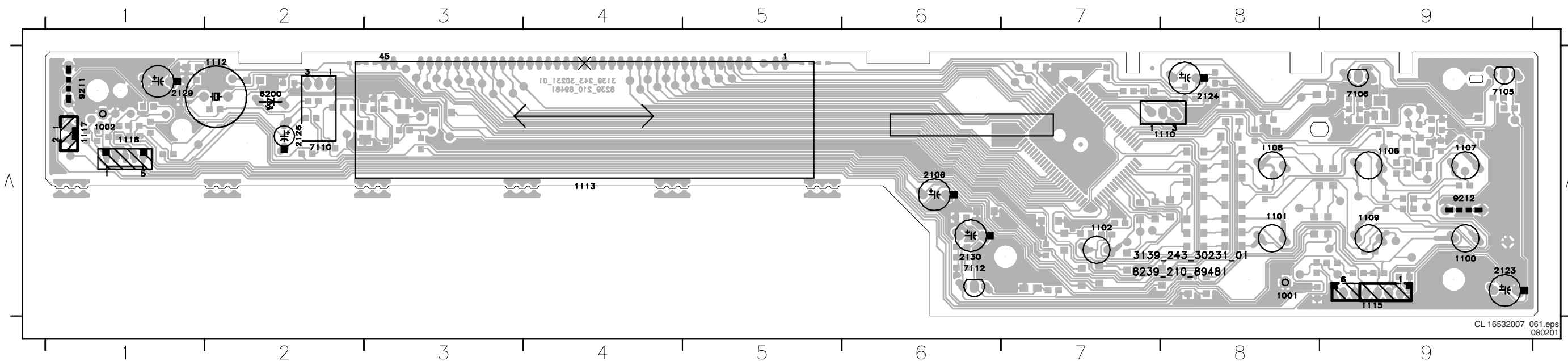

Layout Display Board (bottom side)

2100 A1 2109 A4 2116 A9 3100 A1 3105 A8 3110 A1 3115 A3 3122 A9 3133 A8 3138 A2 3144 A9 3150 A9 3159 A3 4005 A2 4010 A3 4015 A3 4020 A2 4025 A2 4030 A2 4036 A2 4102 A2 4107 A2 6101 A2 7104 A3
2101 A1 2110 A4 2122 A1 3101 A1 3106 A1 3111 A1 3116 A3 3123 A9 3134 A8 3139 A1 3146 A2 3151 A2 4006 A2 4011 A3 4016 A2 4021 A3 4026 A2 4031 A2 4037 A2 4103 A1 4108 A3 6102 A3 7107 A1
2105 A3 2114 A4 2125 A1 3102 A1 3107 A5 3112 A1 3117 A9 3124 A2 3135 A4 3140 A1 3147 A3 3152 A2 4007 A1 4012 A3 4017 A2 4022 A2 4027 A2 4032 A3 4038 A4 4104 A1 4111 A7 6104 A9 7108 A7
2107 A3 2114 A9 2128 A7 3103 A8 3108 A5 3113 A9 3118 A1 3125 A9 3136 A8 3141 A3 3148 A2 4008 A2 4013 A2 4018 A2 4023 A3 4028 A2 4034 A7 4100 A9 4105 A2 4112 A7 6105 A8 7109 A8
2108 A4 2115 A9 2201 A7 3104 A1 3109 A8 3114 A1 3119 A3 3126 A1 3137 A8 3142 A1 3149 A3 3156 A2 4009 A3 4014 A2 4019 A2 4024 A2 4029 A3 4035 A3 4101 A8 4106 A2 6100 A1 7101 A1

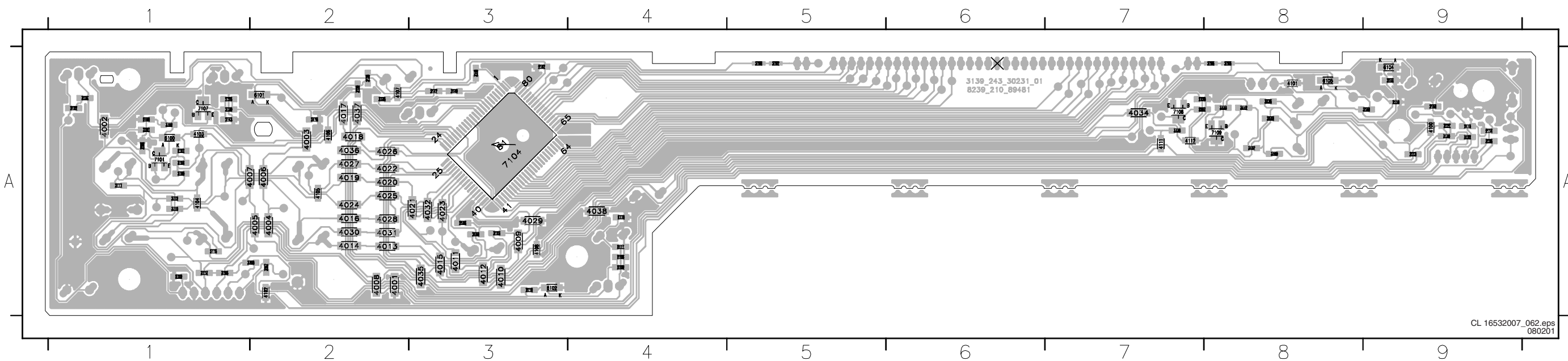

Bare board Standby

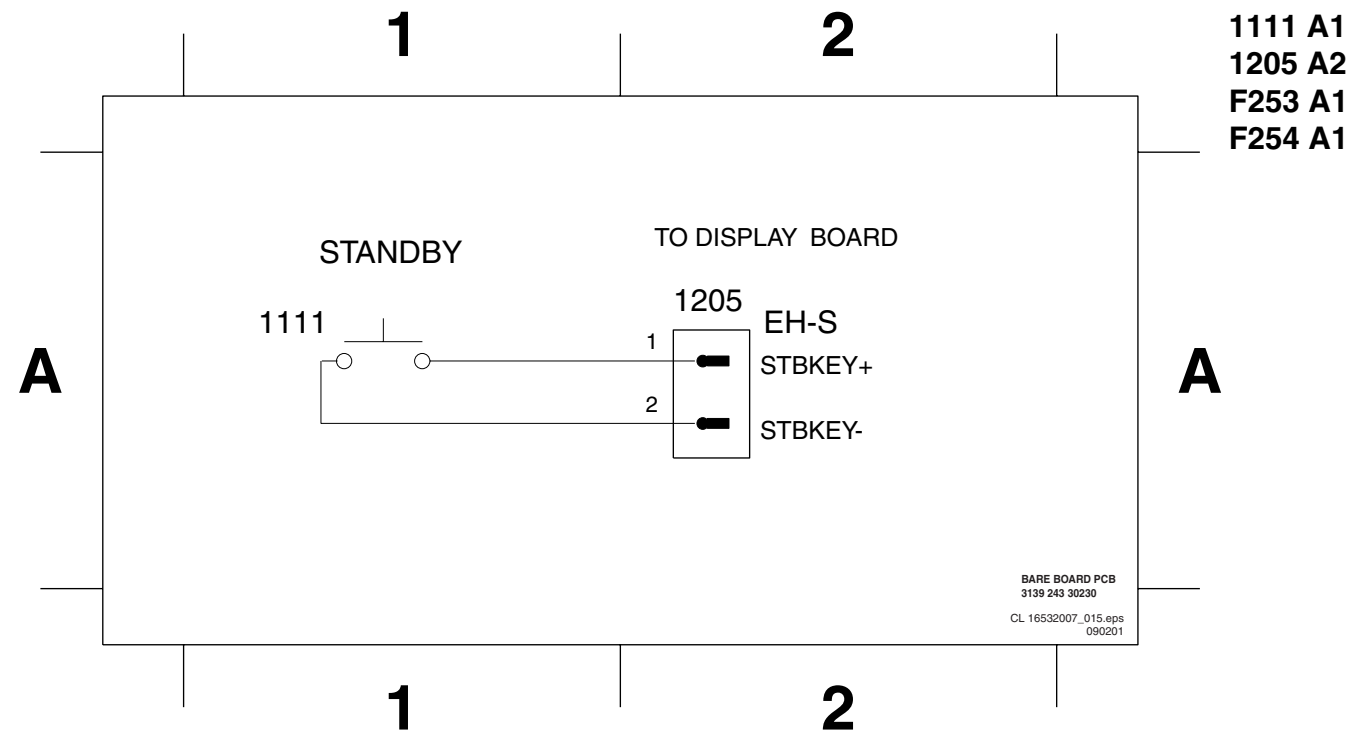

Layout Bare board Standby

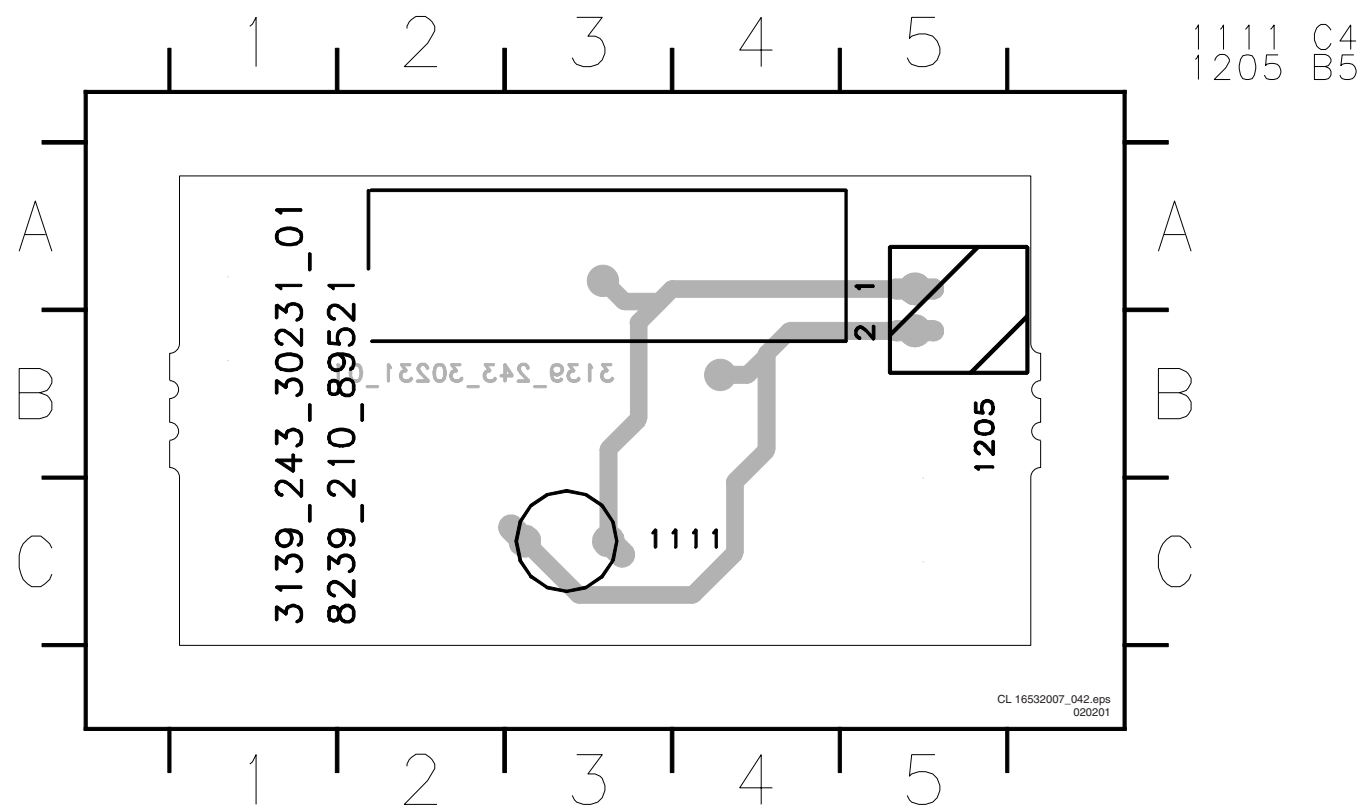

8. Alignments

No electrical alignments available

9. Circuit descriptions and list of abbreviations

9.1 Current mode Power Supply

9.1.1 Introduction

The switch mode power supply (SMPS) is mains isolated. The control IC 7145 (UC 3842A) produces pulses to drive the power switch, Mosfet 7125.

Power supply regulation is achieved by using duty cycle control at fix frequency ,of approximately 58KHz ,determined by the RC timing components.

9.1.2 General Description of UC 3842A

The UC 3842 is a high performance fixed frequency current mode controller that is specifically designed for off-line and

9.1.3 BLOCK DIAGRAM

DC-to-DC converter application. This integrated circuit feature a trimmed oscillator for precise duty cycle control, a temperature compensated reference, high gain error amplifier, current sensing comparator and a high current totem pole output ideally suited for driving a power MOSFET. Also included are protective features consisting of input and reference undervoltage lockouts each with hysteresis, cycle by cycle current limiting, programmable output deadtime and a latch for single pulse metering.

A representative Block diagram and Pin function description is shown in Fig 1 and Fig 2 respectively.

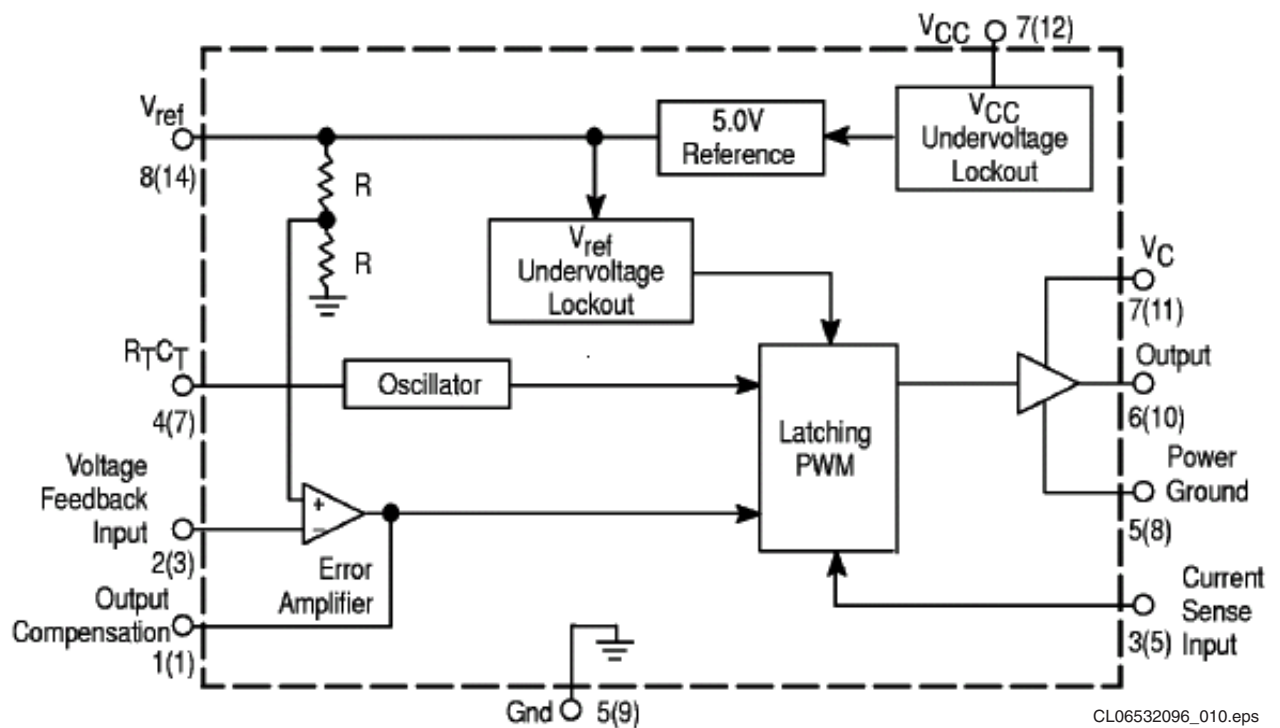

Figure 9-1

9.1.4 Pin function description

Pin		Function	Description
8-Pin	14-Pin		
1	1	Compensation	This pin is Error Amplifier output and is made available for loop compensation.
2	3	Voltage Feedback	This is the inverting input of the Error Amplifier. It is normally connected to the switching power supply output through a resistor divider.
3	5	Current Sense	A voltage proportional to inductor current is connected to this input. The PWM uses this information to terminate the output switch conduction.
4	7	R_T/C_T	The Oscillator frequency and maximum Output duty cycle are programmed by connecting resistor R_T to V_{ref} and capacitor C_T to ground. Operation to 500 kHz is possible.
5	-	Gnd	This pin is the combined control circuitry and power ground (8-pin package only).
6	10	Output	This output directly drives the gate of a power MOSFET. Peak currents up to 1.0 A are sourced and sunk by this pin.
7	12	V_{CC}	This pin is the positive supply of the control IC.
8	14	V_{ref}	This is the reference output. It provides charging current for capacitor C_T through resistor R_T .
-	8	Power Ground	This pin is a separate power ground return (14-pin package only) that is connected back to the power source. It is used to reduce the effects of switching transient noise on the control circuitry.
-	11	V_C	The Output high state (V_{OH}) is set by the voltage applied to this pin (14-pin package only). With a separate power source connection, it can reduce the effects of switching transient noise on the control circuitry.
-	9	Gnd	This pin is the control circuitry ground return (14-pin package only) and is connected back to the power source ground.
-	2,4,6,13	NC	No connection (14-pin package only). These pins are not internally connected.

CL06532096_011.eps
060700

Figure 9-2

9.1.5 Pin connection

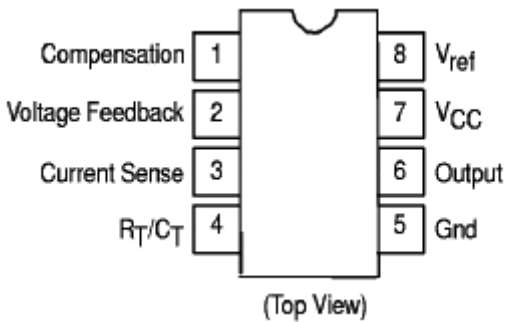

CL06532096_012.eps
060700

Figure 9-3

9.1.6 Output voltages

- +12V (For Display board, Monoboard, A/V board) created via D6241, C2240, L5240, C2232 (This voltage is also present during standby)
- +5V_ stdby (For Display board, Standby PCB, Monoboard) created from +6V via R3233 and D6233 (This voltage is also present during standby)
- +6V_ stdby (Reserve) created from D6230, C2230, L5231 (This voltage is also present during standby)
- +5V (For Monoboard, A/V board) derive from +6V stdby via Mosfet 7238, C2239 and it will be switch off via R3235, T7235 during Standby.
- 5V (For Monoboard, A/V board) created from D6250, C2250, C2259, L5222, R3259, T7255 regulator circuit and will switch off via R3258, T7257 during standby (control signal Standby is HIGH)

- 3V3 (For Monoboard, A/V board) The 3V3 power supply is regulated by the control loop comprising of 7201, 7131 and 7145 of the switch mode PSU. This voltage is also present during standby
- 40V (For Display board) created via D6261, R3260, L5260, C2260 This will not be present during standby

9.2 CONTROL CIRCUITRY

9.2.1 Mains input circuit

The mains voltage is rectified by bridge rectifier (D6118 to D6121) and filter by C2121. The DC voltage across C2121 is the DC input voltage ,approximately 300V, is the DC input to pin 1 of transformer T5131. The mains input also consists of a lighting protection R3120.

9.2.2 Start-up and takeover circuitry

The start-up circuitry consist R3123, R3134, R3111, D6129, C2134 and with the mains voltage input, the C2134 will charge via R3123 and R3134. When the voltage at pin 7 of IC7145 reaches the start-up threshold of min 14.5V, IC7145 will start-up and the control circuit start to operate. After start-up, the max sinking current of 17mA is required by IC7145 which is not able to be delivered by the start-up circuitry, so the takeover circuitry must be present. If the takeover circuit does not occurred, the supply voltage at pin 7 will decrease gradually till it reaches the IC7145 minimal operating voltage of 8.5V and the IC will switch off. The whole operation cycle will repeat itself with audible hiccup sound if takeover is not present.

The takeover circuit comprises of D6133, R3135, I5135, C2134. During the control circuit start-up, the voltage across winding pin 7 and 9 will gradually built up and charged C2134

via D6133, R3135 which will takeover the supply voltage of T7145 at pin 7.

it goes into the overvoltage protection and a complete restart sequence is required.

9.2.3 Secondary voltage sensing

The secondary voltage regulating circuit comprise of the opto-coupler 7131 which isolate the error signal from the control IC7145 ,on the primary side, and a reference component 7201 (TL431). The 7201 can be represented by two components:

- A very stable and accurate reference diode
- A high gain amplifier

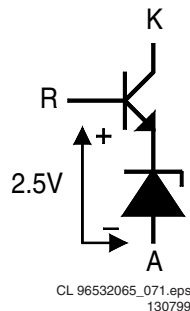

Figure 9-4

When the output voltage increases, due to a reduction in the load, the voltage across R3205 and R3206 increases to above the internal reference voltage of about 2.5V then TL431 conduct. The current through the opto-coupler 7131 will increase due to the fact that the series resistor in 7201 decreases. This result in a increase of voltage to pin 2 of IC7145, thus reducing the on-time of FET 7125. In the event of a decrease in output voltage (increase in load),the control circuit will operate in the opposite way to the explanation above.

9.2.4 Primary current sensing

The current through the FET 7125 resulting in a voltage drop across R3126,R3127,R3128 which is couple to pin 3 of IC7145,current sense input.The higher the input voltage, the more the primary current is limited. In this way the maximum output power of the power supply is limited.

9.2.5 Undervoltage protection

Two undervoltage lockout comparators have been incorporated to guarantee that the IC7145 is fully functional before the output stage is enable. The supply voltage at pin 7 and reference voltage at pin 8 of IC7145 are each monitored by separate comparators with built-in hysteresis. If the supply voltage at pin 7 of IC7145 drops below 10V (typical), due to a secondary voltage is short-circuit or excessive load, the drive pulse at pin 6 of IC7145 will be disabled and the controller will switch off the complete SMPS.

Remarks : In the event of the overvoltage situation remaining present, the SMPS will go in sequence of protection,start- up cycle, protection and the cycle repeats. This effect is highly audible.

9.2.6 Overvoltage protection

The overvoltage circuitry comprising of D6141,R3139, R3150, R3141,T7141, T7150 which is used to detect an over voltage situation on the secondary side of the transformer. After start-up, when the voltage across C2135 exceeds 18V,the overvoltage circuit will trigger the internal latch circuit, pin 1 of IC7145 and the output buffer is disabled and

9.3 List of abbreviations

B	Buffered Video input Blue from DVD monoboard
BC_AUX	Blue or Chroma input from AUX-scart
BC_TV	Blue or Chroma output to TV-scart
C_ENC	Buffered Chroma input from DVD monoboard
CVBS	Buffered Composite video input from DVD monoboard
DC_OFF	Control signal to switch off $\hat{u}8V_{stby}$ and $+12V_{stby}$ during standby
DIG_OUT	Digital out
FBIN_AUX	Fast blanking input from AUX-scart
FBOU_TV	Fast blanking output to TV-scart
G	Buffered Video input Green from DVD monoboard
GIN_AUX	Video input Green from AUX-scart
GOUT_TV	Video output Green to TV-scart
HP_L	Audio output left to headphone and audio scart switch TEA6420
HP_R	Audio output right to headphone and audio scart switch TEA6420
KILL	Kill control signal for audio outputs and for soft mute of DAC
LIN_AUX	Audio input left from AUX-scart
LIN_TV	Audio input left from TV-scart
LOUT_AUX	Audio output left to AUX-scart
LOUT_TV	Audio output left to TV-scart
LRCLK	Left/Right clock
PCM_CLK	Audio system clock for DAC
PCM_OUT0	Audio serial output data
R	Buffered Video input Red from DVD monoboard
RCIN_TV	Red or Chroma input from TV-scart
RCOUT_TV	Red or Chroma output to TV-scart
RIN_AUX	Audio input right from AUX-scart
RIN_TV	Audio input right from TV-scart
ROUT_AUX	Audio output right to AUX-scart
ROUT_TV	Audio output right to TV-scart
SCL	I2C bus clock
SCLK	Audio serial bit clock
SDA	I2C bus data
SELECT	Control signal for video scart switches; high = TV ,low = AUX
SELECT_HIGH	Control signal for switching fast blanking and slow blanking signals; high = TV ,low = AUX
SLB_AUX	Slow blanking control signal from AUX-scart
SLB_TV	Slow blanking control signal to TV-scart
STANDBY	Control signal from ST15505 used to switch off $\hat{u}8V_{stby}$ and $+12V_{stby}$ during standby.
STEREO_L	Audio cinch output left
STEREO_R	Audio cinch output right
Y_ENC	Buffered Luma input from DVD monoboard
YCVBSIN_AUX	Luma or CVBS input from AUX-scart
YCVBSIN_TV	Luma or CVBS input from TV-scart
YCVBSOUT_AUX	Luma or CVBS output to AUX-scart
YCVBSOUT_TV	Luma or CVBS output to TV-scart
0/6/12	Scart switch control signal A/V board. 0V : loop through (AUX to TV), 6V : play 16:9 format, 12V : play 4:3 format

10. Spare parts list

DVD612 /001

Various

0010	3139 247 52811	CAB FRONT DVD612/00X PPT
0025	3139 247 52941	BTN STANDBY DVD612/00X PPT
0030	3139 247 52851	WINDOW DVD612/00X PPT
0040	3139 247 52911	BTN CONTROL DVD612/00X PPT
0200	3139 247 52771	FRONT ASSY DVD612/00X
0224	3139 247 53011	BACK PLATE DVD612/00X PPT
0232	3139 247 52991	COVER TOP DVD612/00X PPT
0261	4822 321 11139	POWER CORD
0333	4822 321 11357	AUDIO CORD SET
0382	3111 170 21992	SCART CABLE (L=1.10M) BMS
0384	3139 228 87051	PROD.ASSY RC19133001/01 PACKED
0387	3139 246 10681	IFU DVD612/00X
1002	3139 248 80861	PCBAS AV DVD612 EU
1003	3139 248 80941	PCBAS FR DVD612 EU
1005	3122 427 22572	PSU DVD VFM EURO
1014	3104 157 11190	CWAS FLEX DVD 22 130 32S

AV PWB

Various

1002	2422 025 12352	CON BM EURO H 21P F BK GRND-L
1005	4822 265 11566	3P YKC21-3930
1010	2422 025 16526	CON BM V 22P F 1.00 FFC 0.3 R
1011	4822 267 31729	

-II-

2101	4822 124 40207	100µF 20% 25V
2103	4822 124 40207	100µF 20% 25V
2104	4822 124 40207	100µF 20% 25V
2105	4822 124 40207	100µF 20% 25V
2106	4822 126 14305	100nF 10% 16V 0603
2109	4822 124 40207	100µF 20% 25V
2111	4822 126 14494	22nF 10% 25V 0603
2112	4822 122 31765	100pF 2% 63V
2115	4822 126 13883	220pF 5% 50V
2116	4822 126 13883	220pF 5% 50V
2117	4822 126 13883	220pF 5% 50V
2200	4822 126 14305	100nF 10% 16V 0603
2201	4822 124 80231	47µF 20% 16V
2202	4822 124 80231	47µF 20% 16V
2203	4822 126 14305	100nF 10% 16V 0603
2204	4822 124 23432	100µF 20% 10V
2205	4822 124 40207	100µF 20% 25V
2206	4822 124 80231	47µF 20% 16V
2207	4822 126 14305	100nF 10% 16V 0603
2208	4822 124 11947	10µF 20% 16V
2209	3198 017 44740	0603 10V 470nF COL
2210	4822 126 14305	100nF 10% 16V 0603
2211	4822 124 40207	100µF 20% 25V
2212	3198 016 31020	0603 25V 1nF
2213	4822 126 14305	100nF 10% 16V 0603
2214	4822 122 31765	100pF 2% 63V
2215	3198 016 31020	0603 25V 1nF
2216	4822 124 11947	10µF 20% 16V
2226	4822 124 40207	100µF 20% 25V
2227	4822 124 11947	10µF 20% 16V
2228	3198 016 31020	0603 25V 1nF
2229	4822 122 31765	100pF 2% 63V
2230	3198 016 31020	0603 25V 1nF
2232	4822 124 11947	10µF 20% 16V
2233	4822 122 33777	47pF 5% 63V
2234	4822 126 14305	100nF 10% 16V 0603
2235	4822 122 33777	47pF 5% 63V
2236	4822 124 40207	100µF 20% 25V
2237	4822 124 80195	470µF 20% 10V
2243	4822 126 13883	220pF 5% 50V
2244	4822 126 13883	220pF 5% 50V
2249	4822 122 33761	22pF 5% 50V



3100	4822 051 20008	0Ω jumper . (0805)
3111	4822 051 30271	270Ω 5% 0.062W
3113	4822 051 30101	100Ω 5% 0.062W
3114	4822 051 30101	100Ω 5% 0.062W
3115	4822 117 12968	820Ω 5% 0.62W
3116	4822 051 30682	6k8 5% 0.062W
3117	4822 051 30222	2k2 5% 0.062W
3118	4822 051 30681	680Ω 5% 0.062W
3119	4822 051 30472	4k7 5% 0.062W
3120	4822 051 30759	75Ω 5% 0.062W
3121	4822 051 30271	270Ω 5% 0.062W
3122	4822 051 30101	100Ω 5% 0.062W
3123	4822 051 30101	100Ω 5% 0.062W
3124	4822 051 30759	75Ω 5% 0.062W
3125	4822 051 30682	6k8 5% 0.062W
3126	4822 117 12968	820Ω 5% 0.62W
3127	4822 051 30222	2k2 5% 0.062W
3128	4822 051 30681	680Ω 5% 0.062W
3129	4822 051 30472	4k7 5% 0.062W
3130	4822 051 30221	220Ω 5% 0.062W
3131	4822 051 30271	270Ω 5% 0.062W
3132	4822 051 30101	100Ω 5% 0.062W
3133	4822 051 30101	100Ω 5% 0.062W
3134	4822 051 30759	75Ω 5% 0.062W
3135	4822 117 12968	820Ω 5% 0.62W
3136	4822 051 30682	6k8 5% 0.062W
3137	4822 051 30222	2k2 5% 0.062W
3138	4822 051 30472	4k7 5% 0.062W
3139	4822 051 30681	680Ω 5% 0.062W
3146	4822 051 30759	75Ω 5% 0.062W
3147	4822 051 30223	22k 5% 0.062W
3148	4822 051 30102	1k 5% 0.062W
3149	4822 116 83884	47k 5% 0.5W
3169	4822 051 30102	1k 5% 0.062W
3170	4822 051 30102	1k 5% 0.062W
3202	4822 051 30681	680Ω 5% 0.062W
3203	4822 116 52228	680Ω 5% 0.5W
3204	4822 116 52195	47Ω 5% 0.5W
3205	4822 117 12902	8k2 1% 0.063W 0603
3206	4822 051 30472	4k7 5% 0.062W
3207	4822 117 11152	4Ω7 5%
3208	4822 051 30103	10k 5% 0.062W
3210	4822 051 30103	10k 5% 0.062W
3211	4822 051 30272	2k7 5% 0.062W
3212	4822 051 30103	10k 5% 0.062W
3213	4822 051 30272	2k7 5% 0.062W
3225	4822 051 30681	680Ω 5% 0.062W
3226	4822 051 30103	10k 5% 0.062W
3227	4822 051 30272	2k7 5% 0.062W
3228	4822 116 52228	680Ω 5% 0.5W
3229	4822 116 52263	2k7 5% 0.5W
3230	4822 051 30103	10k 5% 0.062W
3231	4822 117 12902	8k2 1% 0.063W 0603
3232	4822 051 30472	4k7 5% 0.062W
3233	4822 051 30103	10k 5% 0.062W
3235	4822 116 52175	100Ω 5% 0.5W
3236	4822 051 30689	68Ω 5% 0.063W 0603 RC21 RST SM
3237	4822 117 11152	4Ω7 5%
3238	4822 051 30472	4k7 5% 0.062W
3239	4822 117 13632	100k 1% 0603 0.62W
3240	4822 051 30271	270Ω 5% 0.062W
3241	4822 051 30101	100Ω 5% 0.062W
3242	4822 051 30759	75Ω 5% 0.062W
3243	4822 117 12968	820Ω 5% 0.62W
3244	4822 051 30682	6k8 5% 0.062W
3245	4822 051 30222	2k2 5% 0.062W
3246	4822 051 30472	4k7 5% 0.062W
3247	4822 051 30681	680Ω 5% 0.062W
3248	4822 051 30759	75Ω 5% 0.062W
3249	4822 051 30222	2k2 5% 0.062W
4xxx	4822 051 10008	0Ω 5% 0.25W (1206)
4xxx	4822 051 20008	0Ω 5% 0.25W (0805)



5200 4822 157 70601 100µH (920927085A)



6102 4822 130 11522 UDZ15B
6103 4822 130 11522 UDZ15B

Front PWB

Various

1100	4822 276 13775	SWITCH
1101	4822 276 13775	SWITCH
1102	4822 276 13775	SWITCH
1106	4822 276 13775	SWITCH
1107	4822 276 13775	SWITCH
1108	4822 276 13775	SWITCH
1109	4822 276 13775	SWITCH
1110	2422 540 98423	RES CER 8MHz CSTS*MHz 03
1111	4822 276 13775	SWITCH
1113	3139 240 50021	FTD 11-MT-126GNK DVD602
1115	4822 267 10565	4P
1117	2412 020 00724	CON BM V 2P M 2.50 EH B
1118	4822 267 10637	B5B-PH-K (5P)
1205	2422 025 12488	CON BM H 2P M 2.50 EH B

-II-

2100	4822 126 13883	220pF 5% 50V
2101	4822 126 13883	220pF 5% 50V
2105	4822 126 14549	33nF 16V O6O3
2106	4822 124 40207	100µF 20% 25V
2107	3198 024 44730	47nF 50V 0603
2108	3198 024 44730	47nF 50V 0603
2109	3198 024 44730	47nF 50V 0603
2110	3198 024 44730	47nF 50V 0603
2111	3198 024 44730	47nF 50V 0603
2114	4822 122 33761	22pF 5% 50V
2115	4822 122 33761	22pF 5% 50V
2116	4822 126 14549	33nF 16V O6O3
2122	4822 126 14549	33nF 16V O6O3
2123	4822 124 40207	100µF 20% 25V
2124	3198 028 42290	EL 5MM 35V 22µF PM20 COL A
2125	4822 122 33761	22pF 5% 50V
2126	4822 124 11947	10µF 20% 16V
2128	5322 126 11578	1nF 10% 50V 0603
2129	3198 028 42290	EL 5MM 35V 22µF PM20 COL A
2130	4822 124 41751	47µF 20% 50V
2201	4822 126 14549	33nF 16V O6O3



3100	4822 051 30223	22k 5% 0.062W
3101	4822 051 30273	27k 5% 0.062W
3102	4822 117 12925	47k 1% 0.063W 0603
3103	4822 117 13608	4.7Ω 5% 0603 0.0016W
3104	4822 117 13632	100k 1% 0603 0.62W
3105	4822 117 13613	2Ω2 5% 0603
3106	4822 051 30221	220Ω 5% 0.062W
3107	4822 117 13608	4.7Ω 5% 0603 0.0016W
3108	4822 117 13613	2Ω2 5% 0603
3109	4822 051 30472	4k7 5% 0.062W
3110	4822 051 30472	4k7 5% 0.062W
3111	4822 051 30472	4k7 5% 0.062W
3112	4822 051 30472	4k7 5% 0.062W
3113	4822 051 30472	4k7 5% 0.062W
3114	4822 051 30109	10Ω 5% 0.062W
3115	4822 051 30472	4k7 5% 0.062W
3118	4822 051 30103	10k 5% 0.062W
3119	4822 051 30103	10k 5% 0.062W
3120	4822 051 30471	470Ω 5% 0.062W
3121	4822 051 30472	4k7 5% 0.062W
3122	4822 051 30109	10Ω 5% 0.062W
3123	4822 051 30103	10k 5% 0.062W
3125	4822 051 30109	10Ω 5% 0.062W
3130	4822 051 30109	10Ω 5% 0.062W
3132	4822 051 30331	330Ω 5% 0.062W
3133	4822 051 30109	10Ω 5% 0.062W
3134	4822 051 30331	330Ω 5% 0.062W
3136	4822 051 30102	1k 5% 0.062W
3138	4822 051 30471	470Ω 5% 0.062W
3139	4822 051 30472	4k7 5% 0.062W
3140	4822 051 30103	10k 5% 0.062W
3143	4822 051 30103	10k 5% 0.062W
3144	4822 117 13632	100k 1% 0603 0.62W
3146	4822 051 30103	10k 5% 0.062W
3147	4822 051 30103	10k 5% 0.062W
3148	4822 051 30101	100Ω 5% 0.062W
3149	4822 051 30101	100Ω 5% 0.062W

3155 4822 051 30008 0Ω jumper
3156 4822 051 30008 0Ω jumper
3159 4822 051 30472 4k7 5% 0.062W



6100 4822 130 11397 BAS316
6101 9965 000 04709 UD26.2BTE-17
6102 4822 130 10837 UDZS8.2B
6104 4822 130 11397 BAS316



7101 4822 130 60511 BC847B
7104 3104 123 94532 TMP87CH74F-1E29-V2.18-DVDSLAVE
7105 4822 130 40981 BC337-25
7106 4822 130 40854 BC327
7107 4822 130 60511 BC847B
7108 4822 130 60511 BC847B
7110 9322 155 98667 IR RECEIVER
TSOP2236YA1(VISH)L
7112 4822 209 31257 MC79L24ACP

PSU PWB

Various

0101▲ 4822 265 20723 B2P3-VH
0120▲ 4822 265 11253 FUSE HOLDER 2P
0205 2422 025 08333 CON BM V 12P M 2.50 EH
B
0208 4822 267 10565 4P
1120▲ 4822 253 30383 19181 (2,5A)



2120▲ 4822 121 10711 100nF 20% 275V
2121 2222 151 90048 47μF 20% 400V
2127 4822 122 50116 470pF 10% 1KV
2130▲ 4822 126 13841 1nF 20% 250V
2131▲ 4822 126 13841 1nF 20% 250V
2134 4822 124 11566 47μF 20% 50V
2135 4822 124 22652 2.2μF 20% 50V
2141 4822 124 22652 2.2μF 20% 50V
2143 4822 126 14585 100nF 10% 50V
2145 5322 126 10223 4.7nF 10% 63V
2146 4822 126 14585 100nF 10% 50V
2150 4822 126 14585 100nF 10% 50V
2156 5322 122 31863 63V 330pF PM5
2157 5322 122 32268 63V 470P PM5
2202 4822 126 14585 100nF 10% 50V
2210 2020 012 93728 EL YK 10V S 2200μF PM20
B
2230 2020 012 93757 EL YK 10V S 1000μF PM20
B
2232 4822 124 81021 100μF 20% 16V
2235 4822 126 14549 33nF 16V O6O3
2238 4822 124 81021 100μF 20% 16V
2239 4822 124 81021 100μF 20% 16V
2240 4822 124 81147 470μF 20% YK 25V
2250 4822 124 41545 220μF 20% 16V
2259 4822 124 81021 100μF 20% 16V
2260 4822 124 81151 22μF 50V
2299 5322 122 32654 63V 22nF PM10 R



3111 4822 116 52176 10Ω 5% 0.5W
3120▲ 2322 595 90023 VDR DC 1M A/423V S MAX
800V B
3123 4822 116 52291 56k 5% 0.5W
3125 4822 051 20223 22k 5% 0.1W
3126 4822 116 81801 30Ω 5% 0.5W
3127 4822 116 80176 1Ω 5% 0.5W
3128 4822 116 80176 1Ω 5% 0.5W
3131 4822 051 10274 270k 2% 0.25W
3132▲ 4822 052 11108 1Ω 5% 0.5W
3134 4822 116 52291 56k 5% 0.5W
3135 4822 116 52182 15Ω 5% 0.5W
3136 4822 051 10274 270k 2% 0.25W
3137 4822 117 10837 100k 1% 0.1W
3139 4822 051 20479 47Ω 5% 0.1W
3140 4822 116 52226 560Ω 5% 0.5W
3141 4822 117 11507 6k8 1% 0.1W
3143 3198 021 53630 36k 5% 0.1W 0805
3145 4822 117 10965 18k 1% 0.1W
3146 4822 117 11148 56k 1% 0.1W
3150 4822 117 11139 1k5 1% 0.1W
3153 4822 116 83933 15k 1% 0.1W

3154 4822 117 11139 1k5 1% 0.1W
3155 4822 116 52219 330Ω 5% 0.5W
3156 4822 051 20339 33Ω 5% 0.1W
3201 4822 116 52176 10Ω 5% 0.5W
3202 4822 117 11141 1k8 1% 0.1W
3204 4822 117 11504 270Ω 1% 0.1W
3205 4822 117 11145 4k7 1% 0.1W
3206 4822 051 20391 390Ω 5% 0.1W
3207 4822 051 10102 1k 2% 0.25W
3233 4822 052 10228 2Ω 2% 0.33W
3235 4822 116 83933 15k 1% 0.1W
3254 4822 051 30223 22k 5% 0.062W
3255 5322 117 13049 470Ω 1% 0.063W 0603
RC22H
3256 5322 117 13053 6k8 1% 0.063W 0603
RC22H
3257 4822 051 30563 56k 5% 0.062W
3258 4822 051 30103 10k 5% 0.062W
3259 4822 051 20102 1k 5% 0.1W
3260 4822 051 20101 100Ω 5% 0.1W
3262 4822 116 83872 220Ω 5% 0.5W
3263 4822 116 52249 1k8 5% 0.5W
4xxx 4822 051 10008 0Ω 5% 0.25W (1206)
4xxx 4822 051 20008 0Ω 5% 0.25W (0805)



5120▲ 4822 157 11846
5121▲ 4822 157 53348 TER CHOKE ASSY
CU15D3
5125 4822 157 11411 100mH z
5131▲ 3128 138 39631 SM TRANSFORMER -
CT282D4
5135 4822 157 70698 27μH
5210 2422 535 94638 IND FXD LHL08 S 6U8
PM20 A
5222▲ 4822 156 20966 47 μH
5231 2422 535 94638 IND FXD LHL08 S 6U8
PM20 A
5240 4822 157 51195 1 μH 20% 4X9.8MM AXIAL
5260 4822 157 11517 10μH 5% 2.3X3.4



6118 4822 130 31603 1N4006
6119 4822 130 31603 1N4006
6120 4822 130 31603 1N4006
6121 4822 130 31603 1N4006
6129 9340 548 67115 DIO REG SM PDZ22B
(PHSE) R
6132 4822 130 30842 BAV21
6133 4822 130 30842 BAV21
6140 4822 130 30621 1N4148
6141 4822 130 11152 UD218B
6150 4822 130 11148 UDZ4.7B
6210 4822 130 11584 BYW98-200-C1
6230 4822 130 41602 BYW95C
6233 4822 130 34174 BZX79-B4V7
6241 4822 130 11584 BYW98-200-C1
6250 4822 130 42488 BYD33D
6261 4822 130 42606 BYD33J



7125 4822 130 11417 STP3NB60FP
7131▲ 9322 149 04682 OPT CP TCET1102(G)
(VISH) L
7141 4822 130 44568 BC557B
7145 9322 145 88682 UC3842A
7150 4822 130 44257 BC547
7201 4822 209 81397 TL431CLPST
7235 4822 130 42705 BC847
7255 4822 130 40855 BC337
7256 5322 130 42756 BC857C
7257 5322 130 42756 BC857C

VAL 6011

Various

0001 9305 023 61101 VAL6011/01

MONO PWB

Various

1104 2422 025 15963 CON BM H 24P F 0.50 FFC
SMD R

1106 2422 025 16158 CON BM H 8P F 1.00 FFC
0.3 R
1205 2422 540 98428 RES CER SM 8M467
CSTCC8.46MHz R
1300 2422 540 98426 RES CER SM 6MHz
CSTCC6.00MHz R
1301 4822 267 51454 CONN. 11P FEMALE
1603 2422 025 16389 CON BM V 22P F 1.00 FFC
0.3 R
1604 2422 025 16388 CON BM V 16P F 1.00 FFC
0.3 R



2100 4822 126 14305 100nF 10% 16V 0603
2101 4822 126 14305 100nF 10% 16V 0603
2103 4822 124 80151 47μF 16V
2104 4822 126 13193 4.7nF 10% 63V
2105 4822 122 33761 22pF 5% 50V
2107 4822 126 13956 68pF 5% 63V CASE 0603
2108 4822 126 14315 390pF 5% 50V 0603
2109 2020 552 95697
2110 2222 861 15222 63V 2N2 PM5
2111 4822 126 14305 100nF 10% 16V 0603
2112 5322 126 11578 1nF 10% 50V 0603
2113 4822 126 14305 100nF 10% 16V 0603
2114 4822 122 31765 100pF 2% 63V
2115 4822 126 14305 100nF 10% 16V 0603
2116 4822 126 14305 100nF 10% 16V 0603
2117 4822 126 14305 100nF 10% 16V 0603
2118 3198 017 42230 0603 50V 22nF COL
2119 3198 017 42230 0603 50V 22nF COL
2120 4822 126 14305 100nF 10% 16V 0603
2121 4822 126 13879 220nF 20% 16V
2122 3198 017 42230 0603 50V 22nF COL
2123 4822 126 14305 100nF 10% 16V 0603
2124 4822 126 14305 100nF 10% 16V 0603
2125 4822 126 14305 100nF 10% 16V 0603
2126 4822 126 14305 100nF 10% 16V 0603
2127 4822 126 14305 100nF 10% 16V 0603
2128 4822 126 14508 180pF 5% 50V 0603
2129 4822 126 14508 180pF 5% 50V 0603
2130 4822 122 33761 22pF 5% 50V
2131 4822 126 14494 22nF 5% 25V 0603
2136 4822 126 14305 100nF 10% 16V 0603
2137 4822 126 14305 100nF 10% 16V 0603
2138 4822 126 14305 100nF 10% 16V 0603
2139 4822 126 14305 100nF 10% 16V 0603
2140 4822 126 14241 0603 50V 330P COL R
2141 4822 122 33761 22pF 5% 50V
2142 5322 126 11583 10nF 10% 50V 0603
2143 4822 126 13883 220pF 5% 50V
2144 4822 126 13883 220pF 5% 50V
2145 4822 126 13883 220pF 5% 50V
2146 4822 126 14305 100nF 10% 16V 0603
2203 4822 126 14305 100nF 10% 16V 0603
2204 4822 126 14305 100nF 10% 16V 0603
2205 4822 126 14305 100nF 10% 16V 0603
2206 4822 126 14549 33nF 16V O6O3
2207 5322 126 11578 1nF 10% 50V 0603
2208 4822 126 14305 100nF 10% 16V 0603
2209 4822 126 14305 100nF 10% 16V 0603
2210 5322 126 11578 1nF 10% 50V 0603
2212 4822 126 14305 100nF 10% 16V 0603
2213 4822 126 14305 100nF 10% 16V 0603
2214 3198 017 42230 0603 50V 22nF COL
2215 4822 124 23237 22μF 6.3V
2216 5322 126 11578 1nF 10% 50V 0603
2226 4822 126 14305 100nF 10% 16V 0603
2227 4822 126 14305 100nF 10% 16V 0603
2228 4822 126 14305 100nF 10% 16V 0603
2300 4822 126 14305 100nF 10% 16V 0603
2301 4822 126 14305 100nF 10% 16V 0603
2302 4822 126 14305 100nF 10% 16V 0603
2303 4822 124 80349 47μF 20% 6.3V
2304 3198 017 42230 0603 50V 22nF COL
2305 3198 017 42230 0603 50V 22nF COL
2306 4822 124 23002 10μF 16V
2307 3198 017 42230 0603 50V 22nF COL
2309 4822 126 14305 100nF 10% 16V 0603
2310 4822 126 14305 100nF 10% 16V 0603
2314 4822 126 14305 100nF 10% 16V 0603
2315 4822 126 14305 100nF 10% 16V 0603
2318 5322 122 33861 120pF 10% 50V
2319 4822 126 11669 27pF
2401 4822 126 14305 100nF 10% 16V 0603
2402 4822 126 14305 100nF 10% 16V 0603
2403 4822 126 14305 100nF 10% 16V 0603
2404 4822 126 14305 100nF 10% 16V 0603
2405 4822 126 14305 100nF 10% 16V 0603
2406 4822 126 14305 100nF 10% 16V 0603
2407 4822 126 14305 100nF 10% 16V 0603
2408 4822 126 14305 100nF 10% 16V 0603

2409	4822 126 14305	100nF 10% 16V 0603	3108	4822 051 20228	2Ω 5% 0.1W	3201	4822 117 11151	1Ω 5%
2410	4822 126 14305	100nF 10% 16V 0603	3110	4822 051 30479	47Ω 5% 0.062W	3202	4822 117 11151	1Ω 5%
2411	4822 126 14305	100nF 10% 16V 0603	3111	5322 117 13058	150Ω 1% 0.063W 0603 RC22H	3203	4822 051 30105	1M 5% 0.062W
2412	4822 126 14305	100nF 10% 16V 0603				3204	4822 051 30331	330Ω 5% 0.062W
2413	4822 126 14305	100nF 10% 16V 0603	3112	5322 117 13021	47Ω 1% 0.063W 0603 RC22H	3205	4822 051 30103	10k 5% 0.062W
2418	4822 124 12095	100μF 20% 16V				3206	4822 051 30103	10k 5% 0.062W
2419	4822 124 80349	47μF 20% 6.3V	3114	4822 051 20228	2Ω 5% 0.1W	3208	4822 051 30272	2k7 5% 0.062W
2420	4822 124 80349	47μF 20% 6.3V	3115	4822 051 20228	2Ω 5% 0.1W	3209	4822 051 30472	4k7 5% 0.062W
2500	4822 126 14305	100nF 10% 16V 0603	3116	5322 117 13042	3k9 1% 0.063W 0603 RC22H	3210	4822 051 30392	3k9 5% 0.063W 0603
2502	3198 030 74780	EL SM 35V 4U7 PM20 COL R				3211	4822 051 30472	4k7 5% 0.062W
			3117	4822 051 30181	180Ω 5% 0.062W	3212	4822 117 11152	4Ω 7 5%
2503	4822 126 14305	100nF 10% 16V 0603	3118	4822 051 30681	680Ω 5% 0.062W	3213	4822 117 11152	4Ω 7 5%
2504	4822 122 31765	100pF 2% 63V	3119	5322 117 13062	390Ω 1% 0.063W 0603 RC22H	3214	4822 051 30392	3k9 5% 0.063W 0603
2505	4822 126 14494	22nF 10% 25V 0603				3215	4822 051 30103	10k 5% 0.062W
2506	4822 124 23002	10μF 16V	3120	4822 051 30102	1k 5% 0.062W	3219	4822 051 30103	10k 5% 0.062W
2507	4822 126 14305	100nF 10% 16V 0603	3121	4822 051 30273	27k 5% 0.062W	3220	4822 051 30103	10k 5% 0.062W
2508	5322 126 11579	3.3nF 10% 63V	3122	4822 051 30471	470Ω 5% 0.062W	3221	4822 051 30103	10k 5% 0.062W
2509	4822 126 14241	0603 50V 330P COL R	3123	4822 051 30103	10k 5% 0.062W	3224	4822 051 30151	150Ω 5% 0.062W
2510	4822 126 14305	100nF 10% 16V 0603	3124	4822 051 30471	470Ω 5% 0.062W	3225	2322 704 62004	
2511	4822 126 14305	100nF 10% 16V 0603	3125	4822 051 30103	10k 5% 0.062W	3226	4822 051 30103	10k 5% 0.062W
2512	4822 126 14305	100nF 10% 16V 0603	3126	4822 051 30103	10k 5% 0.062W	3227	4822 051 30472	4k7 5% 0.062W
2513	4822 126 14305	100nF 10% 16V 0603	3127	4822 051 30223	22k 5% 0.062W	3229	4822 051 30123	12k 5% 0.062W
2514	4822 126 14305	100nF 10% 16V 0603	3128	2322 704 69109		3230	4822 051 30103	10k 5% 0.062W
2515	4822 126 14305	100nF 10% 16V 0603	3129	4822 051 30392	3k9 5% 0.063W 0603	3231	4822 051 30103	10k 5% 0.062W
2516	4822 126 14305	100nF 10% 16V 0603	3130	4822 051 20228	2Ω 5% 0.1W	3232	4822 117 13613	2Ω 2 5% 0603
2517	4822 126 14305	100nF 10% 16V 0603	3131	4822 051 20228	2Ω 5% 0.1W	3234	4822 117 12902	8k2 1% 0.063W 0603
2518	4822 126 14305	100nF 10% 16V 0603	3132	4822 051 20228	2Ω 5% 0.1W	3235	4822 117 13632	100k 1% 0603 0.62W
2519	4822 126 14305	100nF 10% 16V 0603	3133	4822 051 20228	2Ω 5% 0.1W	3236	4822 051 30472	4k7 5% 0.062W
2520	4822 126 14305	100nF 10% 16V 0603	3134	5322 117 13047	330Ω 1% 0.063W 0603 RC22H	3237	4822 051 30103	10k 5% 0.062W
2521	4822 126 14305	100nF 10% 16V 0603				3238	4822 051 30103	10k 5% 0.062W
2522	4822 126 14305	100nF 10% 16V 0603	3135	4822 117 13613	2Ω 5% 0603	3239	4822 051 30008	0Ω jumper
2523	4822 126 14305	100nF 10% 16V 0603	3137	4822 117 13613	2Ω 5% 0603	3240	4822 051 30103	10k 5% 0.062W
2524	4822 126 14305	100nF 10% 16V 0603	3138	5322 117 13053	6k8 1% 0.063W 0603 RC22H	3242	4822 051 30008	0Ω jumper
2525	4822 126 14305	100nF 10% 16V 0603				3243	4822 051 30008	0Ω jumper
2526	4822 126 14305	100nF 10% 16V 0603	3139	4822 117 12917	1Ω 5% 0.062W CASE0603	3246	4822 051 30008	0Ω jumper
2527	4822 126 14305	100nF 10% 16V 0603	3140	4822 051 30479	47Ω 5% 0.062W	3247	4822 051 30008	0Ω jumper
2528	4822 126 14305	100nF 10% 16V 0603	3141	4822 117 11152	4Ω 7 5%	3249	4822 051 30008	0Ω jumper
2529	4822 126 14305	100nF 10% 16V 0603	3142	5322 117 13028	12k 1% 0.063W 0603 RC22H	3250	4822 051 30008	0Ω jumper
2530	3198 030 74780	EL SM 35V 4U7 PM20 COL R				3251	4822 051 30008	0Ω jumper
			3143	5322 117 13043	220Ω 1% 0.063W 0603 RC22H	3252	4822 051 30008	0Ω jumper
						3253	4822 051 30008	0Ω jumper
2531	3198 030 74780	EL SM 35V 4U7 PM20 COL R	3144	2322 704 69109		3254	4822 051 30008	0Ω jumper
			3146	4822 051 30103	10k 5% 0.062W	3255	4822 051 30008	0Ω jumper
2532	4822 122 33777	47pF 5% 63V	3147	4822 051 30103	10k 5% 0.062W	3256	4822 051 30008	0Ω jumper
2533	4822 122 33777	47pF 5% 63V	3148	5322 117 13022	22k 1% 0.063W 0603 RC22H	3257	4822 051 30008	0Ω jumper
2534	5322 126 11578	1nF 10% 50V 0603				3258	4822 051 30008	0Ω jumper
2535	5322 126 11578	1nF 10% 50V 0603	3153	4822 117 12139	22Ω 5% 0.062W	3259	4822 117 11151	1Ω 5%
2600	4822 126 14494	22nF 10% 25V 0603	3155	4822 051 30103	10k 5% 0.062W	3260	4822 117 11151	1Ω 5%
2601	4822 126 14247	0603 50V 1N5 COL R	3157	4822 051 30103	10k 5% 0.062W	3261	4822 051 30102	1k 5% 0.062W
2602	4822 126 14247	0603 50V 1N5 COL R	3158	5322 117 13017	100Ω 1% 0.063W 0603 RC22H	3300	4822 117 11152	4Ω 7 5%
2603	4822 126 14305	100nF 10% 16V 0603				3301	4822 051 30105	1M 5% 0.062W
2604	4822 124 12095	100μF 20% 16V	3160	4822 051 30101	100Ω 5% 0.062W	3302	4822 051 30221	220Ω 5% 0.062W
2605	4822 126 14494	22nF 10% 25V 0603	3161	4822 117 13613	2Ω 5% 0603	3304	4822 051 30272	2k7 5% 0.062W
2606	4822 124 12095	100μF 20% 16V	3162	4822 051 30101	100Ω 5% 0.062W	3305	4822 051 30272	2k7 5% 0.062W
2607	4822 124 12095	100μF 20% 16V	3163	4822 051 30273	27k 5% 0.062W	3309	4822 051 30103	10k 5% 0.062W
2608	4822 124 23002	10μF 16V	3164	4822 117 13613	2Ω 5% 0603	3310	4822 051 30223	22k 5% 0.062W
2609	4822 124 80151	47μF 16V	3165	5322 117 13063	120Ω 1% 0.063W 0603 RC22H	3311	4822 051 30223	22k 5% 0.062W
2610	4822 126 14305	100nF 10% 16V 0603				3312	4822 051 30472	4k7 5% 0.062W
2611	4822 124 12095	100μF 20% 16V	3166	4822 051 30393	39k 5% 0.062W	3313	4822 051 30472	4k7 5% 0.062W
2614	4822 122 33777	47pF 5% 63V	3167	4822 051 30101	100Ω 5% 0.062W	3316	4822 051 20108	1Ω 5% 0.1W
2615	4822 122 33777	47pF 5% 63V	3168	5322 117 13047	330Ω 1% 0.063W 0603 RC22H	3317	4822 051 20108	1Ω 5% 0.1W
2616	4822 122 33777	47pF 5% 63V				3318	4822 051 30472	4k7 5% 0.062W
2617	4822 122 33777	47pF 5% 63V	3169	4822 051 30101	100Ω 5% 0.062W	3319	4822 051 30479	47Ω 5% 0.062W
2618	4822 126 14305	100nF 10% 16V 0603	3170	4822 051 30101	100Ω 5% 0.062W	3320	4822 051 30472	4k7 5% 0.062W
2620	4822 122 33777	47pF 5% 63V	3171	4822 051 30101	100Ω 5% 0.062W	3321	4822 051 30682	6k8 5% 0.062W
2621	4822 122 33777	47pF 5% 63V	3172	4822 117 13632	100k 1% 0603 0.62W	3322	5322 117 13026	4k7 1% 0.063W 0603 RC22H
2622	4822 122 33777	47pF 5% 63V	3173	4822 117 13632	100k 1% 0603 0.62W			
2623	4822 122 33777	47pF 5% 63V	3174	4822 117 11152	4Ω 7 5%	3323	5322 117 13026	4k7 1% 0.063W 0603 RC22H
2624	4822 122 33777	47pF 5% 63V	3175	4822 117 13613	2Ω 5% 0603			
2625	4822 122 33777	47pF 5% 63V	3176	4822 051 30153	15k 5% 0.062W	3324	4822 117 13632	100k 1% 0603 0.62W
2626	4822 122 33777	47pF 5% 63V	3178	4822 117 11151	1Ω 5%	3325	4822 051 30682	6k8 5% 0.062W
2627	4822 122 33777	47pF 5% 63V	3179	4822 051 30221	220Ω 5% 0.062W	3326	4822 051 30479	47Ω 5% 0.062W
2632	4822 124 12095	100μF 20% 16V	3180	4822 117 13632	100k 1% 0603 0.62W	3327	4822 051 30682	6k8 5% 0.062W
2633	4822 124 12095	100μF 20% 16V	3181	4822 051 30561	560Ω 5% 0.062W	3328	4822 051 30223	22k 5% 0.062W
2634	4822 126 14305	100nF 10% 16V 0603	3182	5322 117 13018	1k0 1% 0.063W 0603 RC22H	3329	4822 051 30223	22k 5% 0.062W
2635	4822 126 14305	100nF 10% 16V 0603				3330	4822 051 30223	22k 5% 0.062W
2636	4822 126 14305	100nF 10% 16V 0603	3183	5322 117 13017	100Ω 1% 0.063W 0603 RC22H	3331	4822 051 30332	3k3 5% 0.062W
2637	4822 126 14305	100nF 10% 16V 0603				3332	4822 051 30332	3k3 5% 0.062W
2638	4822 126 14305	100nF 10% 16V 0603	3184	2322 704 61204		3333	4822 051 30101	100Ω 5% 0.062W
2639	4822 126 14305	100nF 10% 16V 0603	3185	4822 117 11151	1Ω 5%	3334	4822 051 30101	100Ω 5% 0.062W
2641	4822 122 33761	22pF 5% 50V	3187	4822 051 30273	27k 5% 0.062W	3335	4822 051 30101	100Ω 5% 0.062W
			3189	4822 051 30008	0Ω jumper	3336	4822 051 30101	100Ω 5% 0.062W
			3190	4822 051 30008	0Ω jumper	3337	4822 051 30101	100Ω 5% 0.062W
			3191	4822 051 30008	0Ω jumper	3338	4822 051 30101	100Ω 5% 0.062W
			3192	4822 051 30008	0Ω jumper	3339	4822 051 30008	0Ω jumper
			3193	4822 051 30008	0Ω jumper	3340	4822 051 30008	0Ω jumper
			3194	4822 051 30008	0Ω jumper	3403	4822 051 30103	10k 5% 0.062W
			3195	4822 051 30008	0Ω jumper	3404	4822 051 30103	10k 5% 0.062W
			3197	4822 051 30008	0Ω jumper	3405	4822 051 30103	10k 5% 0.062W
			3198	5322 117 13049	470Ω 1% 0.063W 0603 RC22H	3412	4822 051 30008	0Ω jumper
						3414	4822 051 30008	0Ω jumper
			3199	5322 117 13042	3k9 1% 0.063W 0603 RC22H	3416	4822 051 30008	0Ω jumper
						3500	4822 051 30332	3k3 5% 0.062W
			3200	4822 051 30103	10k 5% 0.062W	3501	4822 051 30332	

3502	4822 051 30223	22k 5% 0.062W	3657	2322 704 64301	RST SM 0603 RC22H 430Ω PM1 R	7208	9322 139 67685	IC SM MC33464N-45A (MOTA) R
3503	4822 051 30103	10k 5% 0.062W	3658	4822 051 30102	1k 5% 0.062W	7304	4822 209 16877	BA8565FP
3504	4822 051 30103	10k 5% 0.062W	3659	4822 051 30102	1k 5% 0.062W	7310	4822 209 15899	CY7C199-15C
3505	4822 051 30103	10k 5% 0.062W	3660	4822 051 30102	1k 5% 0.062W	7311	9352 637 83557	IC SM SAA7335HL/E/M2 (PHSE) Y
3506	4822 051 30103	10k 5% 0.062W	3661	2322 704 64301	RST SM 0603 RC22H 430Ω PM1 R	7312	4822 130 60373	BC856B
3507	4822 051 30472	4k7 5% 0.062W	3662	4822 051 30102	1k 5% 0.062W	7315	4822 130 60511	BC847B
3508	4822 051 30689	68Ω 5% 0.063W 0603 RC21 RST SM	3663	4822 051 30102	1k 5% 0.062W	7404	9322 144 59668	IC SM MT48LC1M16A1TG- 7S (MRN)R
3509	4822 051 30103	10k 5% 0.062W	3664	2322 704 64301	RST SM 0603 RC22H 430Ω PM1 R	7405	9322 144 59668	IC SM MT48LC1M16A1TG- 7S (MRN)R
3511	4822 051 30332	3k3 5% 0.062W	3665	4822 117 12139	22Ω 5% 0.062W	7501	4822 130 60511	BC847B
3512	4822 051 30332	3k3 5% 0.062W	3667	4822 051 30331	330Ω 5% 0.062W	7503	9322 151 16671	STI5505AVC
3513	4822 051 30103	10k 5% 0.062W	3669	4822 051 30008	0Ω jumper	7504	4822 242 10838	27MHZ 120P FX0-31FT
3514	4822 051 30103	10k 5% 0.062W	3671	4822 051 30222	2k2 5% 0.062W	7505	9322 156 81668	M24C32-WMN6TNKSA
3515	4822 051 30103	10k 5% 0.062W	3672	4822 051 30479	47Ω 5% 0.062W	7600	5322 209 71568	PC74HCT14T
3516	4822 051 30103	10k 5% 0.062W	3673	4822 051 30101	100Ω 5% 0.062W	7604	4822 130 60511	BC847B
3517	4822 051 30332	3k3 5% 0.062W	3677	4822 051 30008	0Ω jumper	7605	4822 209 17398	LD1117DTS33
3519	4822 051 30103	10k 5% 0.062W	3678	4822 051 30008	0Ω jumper	7607	4822 130 60511	BC847B
3520	4822 051 30103	10k 5% 0.062W	3679	4822 051 30008	0Ω jumper	7608	4822 130 60373	BC856B
3521	4822 051 30103	10k 5% 0.062W	3681	4822 051 30008	0Ω jumper	7609	4822 130 60373	BC856B
3522	4822 051 30103	10k 5% 0.062W	3683	4822 051 30008	0Ω jumper	7610	4822 130 60511	BC847B
3523	4822 051 30332	3k3 5% 0.062W	3685	4822 051 30008	0Ω jumper	7611	9352 456 80115	
3524	4822 051 30101	100Ω 5% 0.062W	3686	4822 051 30223	22k 5% 0.062W	7612	4822 130 60511	BC847B
3525	4822 051 30103	10k 5% 0.062W	3687	4822 051 30223	22k 5% 0.062W	7613	4822 130 60511	BC847B
3526	4822 051 30103	10k 5% 0.062W	3688	4822 051 30472	4k7 5% 0.062W	7614	4822 130 60511	BC847B
3534	4822 051 30103	10k 5% 0.062W	3689	4822 051 30223	22k 5% 0.062W	7614	4822 130 60511	BC847B
3535	4822 051 30153	15k 5% 0.062W	3692	4822 051 30103	10k 5% 0.062W	7615	4822 130 60511	BC847B
3536	4822 051 30101	100Ω 5% 0.062W	3693	4822 117 12925	47k 1% 0.063W 0603	7616	9322 151 71668	IC SM MK2703STR (MICL) R
3537	4822 051 30331	330Ω 5% 0.062W	3694	4822 117 13632	100k 1% 0603 0.62W	7617	4822 130 60511	BC847B
3538	4822 051 30681	680Ω 5% 0.062W	3696	4822 051 30472	4k7 5% 0.062W	7618	4822 130 60511	BC847B
3541	4822 051 30479	47Ω 5% 0.062W	3697	4822 117 13632	100k 1% 0603 0.62W	7620	4822 130 60373	BC856B
3542	4822 051 30479	47Ω 5% 0.062W	3698	4822 051 30103	10k 5% 0.062W	7621	4822 130 42804	BC817-25
3545	4822 051 30221	220Ω 5% 0.062W	3699	4822 051 30103	10k 5% 0.062W	7622	4822 130 60511	BC847B
3546	4822 051 30101	100Ω 5% 0.062W	3700	4822 051 30472	4k7 5% 0.062W			
3548	4822 051 30008	0Ω jumper						
3549	4822 051 30008	0Ω jumper						
3550	4822 051 30101	100Ω 5% 0.062W						
3551	4822 051 30101	100Ω 5% 0.062W						
3552	4822 051 30008	0Ω jumper						
3554	4822 051 30008	0Ω jumper						
3564	4822 051 30008	0Ω jumper						
3566	4822 051 30008	0Ω jumper						
3570	4822 051 30101	100Ω 5% 0.062W						
3571	4822 051 30689	68Ω 5% 0.063W 0603 RC21 RST SM						
3572	4822 051 30689	68Ω 5% 0.063W 0603 RC21 RST SM						
3574	4822 051 30008	0Ω jumper						
3605	4822 051 30008	0Ω jumper						
3606	4822 117 12925	47k 1% 0.063W 0603						
3607	4822 117 13632	100k 1% 0603 0.62W						
3608	4822 117 13632	100k 1% 0603 0.62W						
3609	4822 117 13632	100k 1% 0603 0.62W						
3610	4822 051 30103	10k 5% 0.062W						
3611	4822 051 30103	10k 5% 0.062W						
3612	4822 051 30103	10k 5% 0.062W						
3613	4822 051 30103	10k 5% 0.062W						
3614	4822 051 30103	10k 5% 0.062W						
3615	4822 051 30103	10k 5% 0.062W						
3616	4822 051 30103	10k 5% 0.062W						
3618	4822 051 30223	22k 5% 0.062W						
3619	4822 051 30223	22k 5% 0.062W						
3620	4822 051 30101	100Ω 5% 0.062W						
3621	4822 051 30101	100Ω 5% 0.062W						
3622	4822 051 30101	100Ω 5% 0.062W						
3623	4822 051 30101	100Ω 5% 0.062W						
3624	4822 051 30101	100Ω 5% 0.062W						
3625	4822 051 30101	100Ω 5% 0.062W						
3626	4822 051 30102	1k 5% 0.062W						
3627	4822 051 30471	470Ω 5% 0.062W						
3628	4822 051 30471	470Ω 5% 0.062W						
3629	4822 051 30472	4k7 5% 0.062W						
3630	4822 051 30221	220Ω 5% 0.062W						
3631	2322 704 64301	RST SM 0603 RC22H 430Ω PM1 R						
3632	2322 704 64301	RST SM 0603 RC22H 430Ω PM1 R						
3633	2322 704 64301	RST SM 0603 RC22H 430Ω PM1 R						
3635	4822 051 30682	6k8 5% 0.062W						
3636	4822 051 30682	6k8 5% 0.062W						
3637	4822 051 30332	3k3 5% 0.062W						
3642	4822 051 30103	10k 5% 0.062W						
3647	2322 704 64301	RST SM 0603 RC22H 430Ω PM1 R						
3648	2322 704 64301	RST SM 0603 RC22H 430Ω PM1 R						
3651	2322 704 64301	RST SM 0603 RC22H 430Ω PM1 R						
3654	2322 704 64301	RST SM 0603 RC22H 430Ω PM1 R						
3655	2322 704 64301	RST SM 0603 RC22H 430Ω PM1 R						
3656	2322 704 64301	RST SM 0603 RC22H 430Ω PM1 R						
5200	4822 157 11717	BLM31P500SPT	5300	4822 157 11717	BLM31P500SPT			
5301	4822 157 11717	BLM31P500SPT	5402	4822 157 11499	BLM11P600SPT			
5403	4822 157 11499	BLM11P600SPT	5501	4822 157 70299	2.2μH (NL322522T-2R2J)			
5502	4822 157 70299	2.2μH (NL322522T-2R2J)	5503	4822 157 71206	BLM21A601SPT			
5504	4822 157 71206	BLM21A601SPT	5600	4822 157 71206	BLM21A601SPT			
5601	4822 157 11499	BLM11P600SPT	5602	4822 157 70298	15μH (NL322522T-150J)			
5603	4822 157 71206	BLM21A601SPT	5604	4822 157 70298	15μH (NL322522T-150J)			
5605	4822 157 70298	15μH (NL322522T-150J)	5606	4822 157 70298	15μH (NL322522T-150J)			
5607	4822 157 70298	15μH (NL322522T-150J)	5608	4822 157 70298	15μH (NL322522T-150J)			
5609	4822 157 11717	BLM31P500SPT	5610	4822 157 11717	BLM31P500SPT			
6200	4822 130 11397	BAS316						
6301	9322 128 69685	S1D						
6302	9322 128 69685	S1D						
6303	9322 128 69685	S1D						
6600	4822 130 11528	1PS76SB10						
7100	5322 130 42718	BFS20						
7101	5322 130 42718	BFS20						
7102	9352 637 37518	TZA1033HL						
7103	4822 209 17229	BA5938FM						
7104	4822 209 30095	LM833D						
7105	4822 209 32073	MC34072D						
7106	5322 130 42718	BFS20						
7109	4822 209 15083	AN78M09						
7110	5322 130 60803	BST72A						
7111	4822 130 60511	BC847B						
7112	4822 130 60511	BC847B						
7113	4822 130 60511	BC847B						
7114	4822 130 60511	BC847B						
7115	4822 130 60373	BC856B						
7116	4822 130 60511	BC847B						
7117	4822 209 90927	L78L05ACD						
7118	5322 130 60845	BC807-25						
7119	4822 130 42804	BC817-25						
7201	9351 869 80118							
7202	3104 123 85860	AM29F002T/4.3.13						

0382	3111 170 21992	SCART CABLE (L=1.10M) BMS
0384	3139 228 87051	PROD.ASSY RC19133001/ 01 PACKED
0387	3139 246 10711	IFU DVD612/05X
1002	3139 248 80861	PCBAS AV DVD612 EU
1003	3139 248 80941	PCBAS FR DVD612 EU
1005	3122 427 22572	PSU DVD VFM EURO
1014	3104 157 11190	CWAS FLEX DVD 22 130 32S